

# JVC



## ENGLISH

SEE  
AUTO SET UP  
ON REAR SIDE

## VIDEO CASSETTE RECORDER

# HR-DD949E/EH

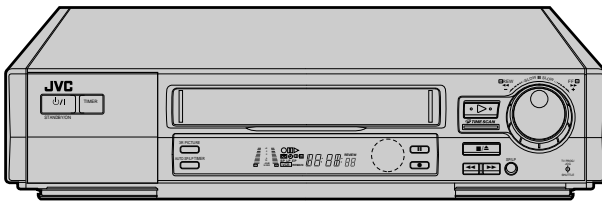

*Hi-Fi* **VHS** PAL **TIME SCAN**

**SHOWVIEW** **G-CODE**

## INSTRUCTIONS

### CONTENTS

<b>SAFETY FIRST</b>	<b>2</b>
Safety Precautions .....	2
<b>INSTALLING YOUR NEW RECORDER</b>	<b>3</b>
Basic Connections .....	3
<b>INITIAL SETTINGS</b>	<b>4</b>
Auto Set Up .....	4
Language .....	7
Video Channel Set .....	8
SHOWVIEW Setup .....	10
<b>PLAYBACK</b>	<b>12</b>
Basic Playback .....	12
Playback Features .....	13
TimeScan .....	18
<b>RECORDING</b>	<b>21</b>
Basic Recording .....	21
B.E.S.T. Picture System .....	22
On-Screen Displays .....	24
Recording Features .....	25
<b>TIMER RECORDING</b>	<b>28</b>
SHOWVIEW Timer Recording .....	28
Regular Timer Programming .....	30
<b>EDITING</b>	<b>34</b>
Edit To Or From Another Video Recorder .....	34
Edit From A Camcorder .....	36
Audio Dubbing .....	37
Insert Editing .....	38
<b>INFORMATION ON J TERMINAL</b>	<b>40</b>
<b>SYSTEM CONNECTIONS</b>	<b>41</b>
Connecting/Using A Decoder ...	41
<b>SPECIAL FEATURES</b>	<b>42</b>
TV Multi-Brand Remote Control .....	42
Satellite Tuner Multi-Brand Remote Control .....	43
<b>TUNER SET</b>	<b>44</b>
<b>CLOCK SET</b>	<b>49</b>
<b>TROUBLESHOOTING</b>	<b>51</b>
<b>QUESTIONS AND ANSWERS</b>	<b>53</b>
<b>INDEX</b>	<b>54</b>
<b>SPECIFICATIONS</b>	<b>57</b>

# Safety Precautions

The rating plate and the safety caution are on the rear of the unit.

**WARNING: DANGEROUS VOLTAGE INSIDE**

**WARNING: TO PREVENT FIRE OR SHOCK HAZARD, DO NOT EXPOSE THIS UNIT TO RAIN OR MOISTURE.**

## CAUTION

- When you are not using the recorder for a long period of time, it is recommended that you disconnect the power cord from the mains outlet.
- Dangerous voltage inside. Refer internal servicing to qualified service personnel. To prevent electric shock or fire hazard, remove the power cord from the mains outlet prior to connecting or disconnecting any signal lead or aerial.

## WARNING

There are two different types of SECAM colour systems: SECAM-L, used in FRANCE (also called SECAM-West), and SECAM-B, used in Eastern European countries (also called SECAM-East).

1. This recorder can also receive SECAM-B colour television signals for recording and playback.
2. Recordings made of SECAM-B television signals produce monochrome pictures if played back on a video recorder of SECAM-L standard, or do not produce normal colour pictures if played back on a PAL video recorder with SECAM-B system incorporated (even if the TV set is SECAM-compatible).
3. SECAM-L prerecorded cassettes or recordings made with a SECAM-L video recorder produce monochrome pictures when played back with this recorder.
4. This recorder cannot be used for the SECAM-L standard. Use a SECAM-L recorder to record SECAM-L signals.

## For Italy:

"It is declared that this product, brand JVC, conforms to the Ministry Decree n. 548 of 28 Aug.'95 published in the Official Gazette of the Italian Republic n. 301 of 28 Dec.'95"



- Only cassettes marked "VHS" can be used with this videorecorder.
- HQ VHS is compatible with existing VHS equipment.
- With this recorder, the G-Code system is identified as "SHOWVIEW" and is operated using the "SHOWVIEW" on screen menu.  
SHOWVIEW is a registered trademark of Gemstar Development Corporation. The SHOWVIEW system is manufactured under licence from Gemstar Development Corporation.  
G-Code is a trademark of Gemstar Development Corporation. The G-Code system is manufactured under license from Gemstar Development Corporation.
- Certain audio features of this product manufactured under a license from Desper Products, Inc. Spatializer® is a trademark owned by Desper Products, Inc.

## IMPORTANT

- Please read the various precautions on this page before installing or operating the recorder.
- It should be noted that it may be unlawful to re-record pre-recorded tapes, records, or discs without the consent of the owner of copyright in the sound or video recording, broadcast or cable programme and in any literary, dramatic, musical, or artistic work embodied therein.

The STANDBY/ON  $\phi$ /I button does not completely shut off mains power from the unit, but switches operating current on and off. "  $\phi$  " shows electrical power standby and " I " shows ON.

Video tapes recorded with this video recorder in the LP (Long Play) mode cannot be played back on a single-speed video recorder.

**Failure to heed the following precautions may result in damage to the recorder, remote control or video cassette.**

1. **DO NOT** place the recorder . . .
  - ... in an environment prone to extreme temperatures or humidity.
  - ... in direct sunlight.
  - ... in a dusty environment.
  - ... in an environment where strong magnetic fields are generated.
  - ... on a surface that is unstable or subject to vibration.
2. **DO NOT** block the recorder's ventilation openings.
3. **DO NOT** place heavy objects on the recorder or remote control.
4. **DO NOT** place anything which might spill on top of the recorder or remote control.
5. **AVOID** violent shocks to the recorder during transport.

## MOISTURE CONDENSATION

Moisture in the air will condense on the recorder when you move it from a cold place to a warm place, or under extremely humid conditions—just as water droplets form in the surface of a glass filled with cold liquid. Moisture condensation on the head drum will cause damage to the tape. In conditions where condensation may occur, keep the recorder turned on for a few hours to let the moisture dry.

## ABOUT HEAD CLEANING

Accumulation of dirt and other particles on the video heads may cause the playback picture to become blurred or interrupted. Be sure to contact your nearest JVC dealer if such troubles occur.

# Basic Connections

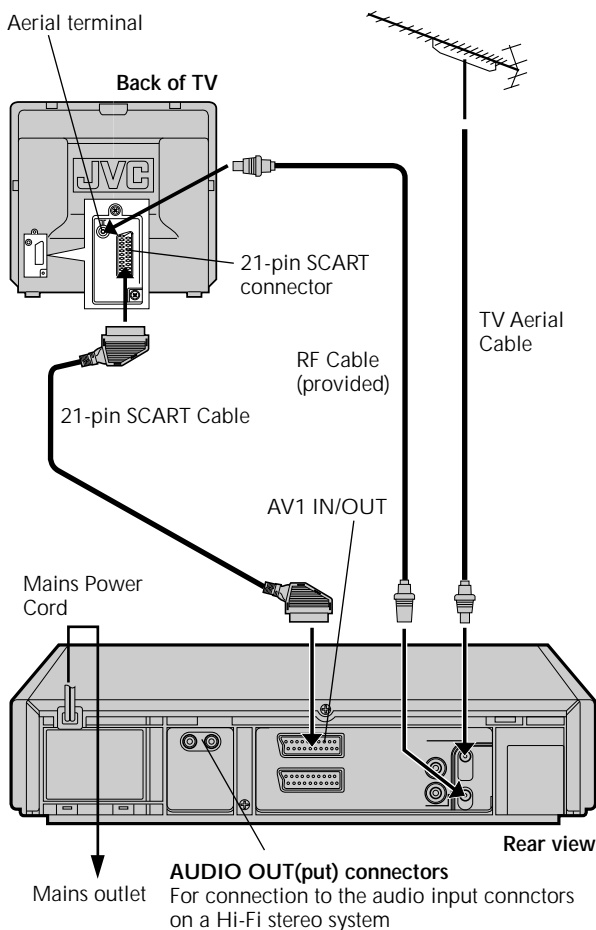

It's essential that your video recorder be properly connected. Follow these steps carefully. THESE STEPS MUST BE COMPLETED BEFORE ANY VIDEO OPERATION CAN BE PERFORMED.

## 1

### CHECK CONTENTS

Make sure the package contains all of the accessories listed in "Specifications" (☞ pg. 57).

## 2

### SITUATE RECORDER

Place the recorder on a stable, horizontal surface.

## 3

### CONNECT RECORDER TO TV

The connection method you use depends on the type of TV you have.

#### RF CONNECTION

- To Connect To A TV With NO AV Input Terminals . . .
  - a- Disconnect the TV aerial cable from the TV.
  - b- Connect the TV aerial cable to the ANT. IN jack on the rear panel of the recorder.
  - c- Connect the provided RF cable between the RF OUT jack on the rear panel of the recorder and the TV's aerial terminal.

Before operating the recorder, make sure the TV's channel is set to the VIDEO channel (☞ pg. 8).

#### AV CONNECTION

- To Connect To A TV With AV Input Terminals . . .
    - a- Connect the aerial, recorder and TV as per "RF CONNECTION".
    - b- Connect an optional SCART cable between the AV1 IN/OUT socket on the rear panel of the recorder and the TV's 21-pin SCART connector.
- If you are using this recorder in Australia or New Zealand, see "For Customers in Australia and New Zealand" on this page.

Before operating the recorder, make sure the TV is set to the VIDEO (or AV) mode.

## 4

### CONNECT RECORDER TO MAINS

Plug the end of the mains power cord into a mains outlet.

After you plug the mains power cord into a mains outlet, the Country Set display appears on the TV screen and/or on the recorder's front display panel when the  $\phi/1$  button on the recorder/remote control is pressed for the first time to power on the recorder; go to page 4 to perform Auto Set Up.

#### For Customers in Australia and New Zealand

Connect an optional AV cable between the TV's AV-IN terminals and the AV1 IN/OUT connector on the rear panel of the recorder via the provided output cable adapter as illustrated.

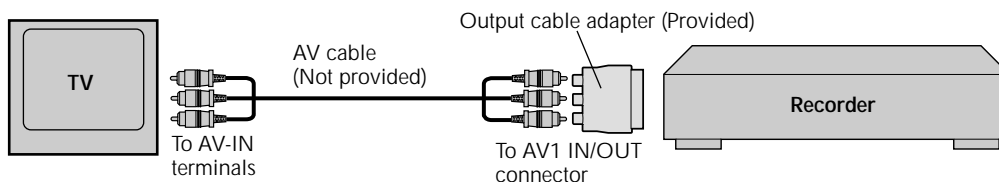

# Auto Set Up

## Auto Channel Set/Auto Clock Set/Auto Guide Program Number Set

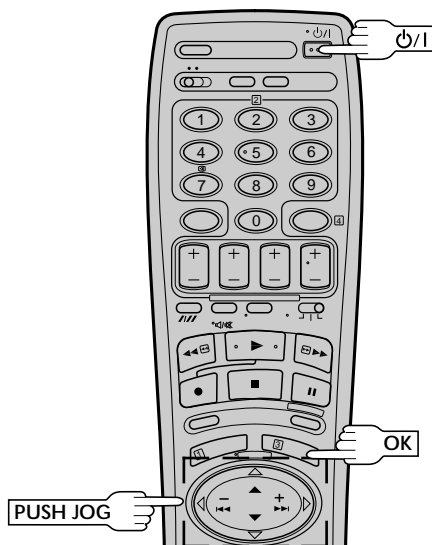
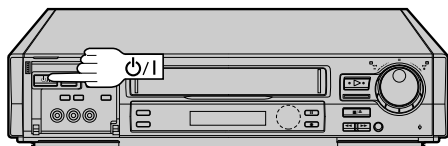

### International Telephone Country Code

SUOMI	: 358	SUISSE	: 41
PORTUGAL	: 351	ITALIA	: 39
DEUTSCHLAND	: 49	ESPAÑA	: 34
NORGE	: 47	BELGIUM	: 32
SVERIGE	: 46	NEDERLAND	: 31
DANMARK	: 45	GREECE	: 30
ÖSTERREICH	: 43	OTHERS	: - -

\* Depending on the model, the selectable codes may be limited.

## ATTENTION

Once you have performed Auto Set Up, even if the recorder's memory backup has expired, all the stored stations and their Guide Program numbers remain in the recorder's memory and the recorder will not perform Auto Set Up again. You only need to set the clock. (pg. 49)

If you have moved to a different area, perform each setting as required.

- Tuner setting (pg. 44)
- Clock setting (pg. 49)
- SHOWVIEW Guide Program number setting (pg. 10)

If a new station starts broadcasting in your area, perform both tuner setting (pg. 44) and SHOWVIEW Guide Program number setting (pg. 10).

When the  $\mathcal{P}/I$  button on the recorder/remote control is pressed for the first time to power on the recorder after you plug the mains power cord into a mains outlet, the Country Set display will appear on the TV screen and the recorder's front display panel. By simply selecting your country\*, the Auto Set Up function sets the tuner channels, clock and Guide Program numbers automatically.

\* If you live in Belgium or Switzerland, you also need to select the language you use.

You can refer to the front display panel and/or the on-screen display to perform this procedure.

Before starting, make sure of the following:

- The TV aerial cable should be connected to the recorder.
- The recorder's mains power cord should be connected to a mains outlet. (pg. 3)
- If you want to use the on-screen display, the TV should be set to its AV mode (with AV connection (pg. 3) or UHF channel 36 (with RF connection (pg. 3)).

## TURN ON THE RECORDER

1

Press  $\mathcal{P}/I$  on the recorder or remote control. The Country Set display appears on the front display panel and/or on the screen.



For HR-DD949E



For HR-DD949EH



For HR-DD949EH



\* The on-screen display differs for the HR-DD949EH depending upon the country in which the product was purchased.

## NOTE:

If you have connected your TV to the recorder with RF connection and the on-screen display appearing on UHF channel 36 looks distorted, perform this procedure referring to the front display panel.

## SELECT COUNTRY

2

**If you are referring to the front display panel**

Press **PUSH JOG**  $\Delta$   $\nabla$  to select your international telephone country code of your country referring to the chart in the left column.

- If you have selected a country code other than 32 (BELGIUM) or 41 (SUISSE), go to step 4.
- If you have selected 32 (BELGIUM) or 41 (SUISSE), go to step 3.

CONTINUED ON NEXT PAGE.

3

**If you are referring to the on-screen display**

Press **PUSH JOG**△▽ to move the highlight bar (pointer) to your country's name.

- If you have selected a country other than BELGIUM or SUISSE, go to step 4.
- If you have selected BELGIUM or SUISSE, go to step 3.

**SELECT LANGUAGE**

Press **OK**. the Language Set display appears on the front display panel and/or on the screen.

**If you are referring to the front display panel**

Press **PUSH JOG**△▽ to select your language code referring to the chart in the left column.

(Ex.) DEUTSCH is selected for SUISSE

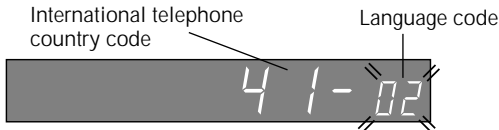

**If you are referring to the on-screen display**

Press **PUSH JOG**△▽ to move the highlight bar (pointer) to the language of your choice.

For HR-DD949E

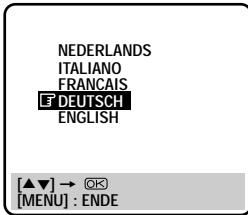

For HR-DD949EH



**Language Code for the HR-DD949E**

ENGLISH	: 01	ITALIANO	: 04
DEUTSCH	: 02	NEDERLANDS	: 05
FRANCAIS	: 03		

**Language Code for the HR-DD949EH**

ENGLISH	: 01	CASTELLANO	: 04
DEUTSCH	: 02	NEDERLANDS	: 05
FRANCAIS	: 03		

4

**PERFORM AUTO SET UP**

Press **OK**.

"Auto" appears on the display panel and blinks; do NOT press any button on the recorder or remote control until the display panel shows the current time or "CH1" or "--:--". (Refer to box on this page.)

- Auto channel set function takes place first; it assigns automatically all receivable stations in your area.
- Auto clock set function sets the clock automatically by reading the clock setting data from a station transmitting a PDC signal while auto channel set is being performed.
- During auto channel set, the recorder recognizes each station name of the detected stations and stores them in the recorder's memory, then automatically sets SHOWVIEW assigned Guide Program number for those stations according to the broadcast area.

**NOTE:**

In the area where no TV station transmits a PDC signal, the recorder can perform neither auto clock set nor auto Guide Program number set.

**Auto Set Up results appear on the front display panel**

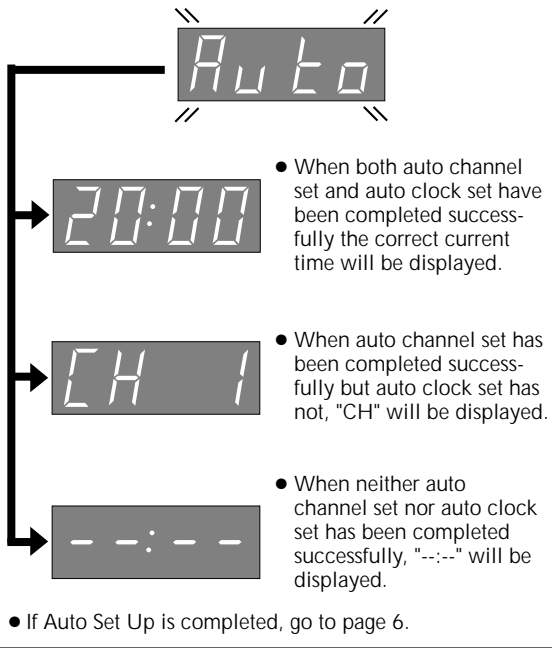

**NOTES:**

- If you are using the on-screen display, the AUTO SET screen will appear after pressing **OK** in step 4. As Auto Set Up progresses, the "■" mark on the screen moves from left to right.
- If there is a power cut, or if you press **PS/1** or **MENU** while Auto Set Up is in progress, Auto Set Up will be interrupted; be sure to turn off the recorder power once and try again from step 1.

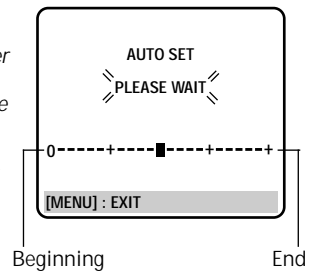

**If both auto channel set and auto clock set have been performed successfully:**

- 1 Perform "Video Channel Set" on page 8.
- 2 Turn on the TV and select its VIDEO channel or AV mode, then make sure that all necessary stations have been stored in the recorder's memory by using the **TV PROG.** button(s).
  - If station names (ID —  pg. 48) have also been stored in the recorder's memory, the station name will be displayed at the top left corner of the screen for about 5 seconds when the recorder is tuned to a different station.
  - If you want to set the tuner manually such as to add or skip channels, to change channel positions, or to set or change station names, see pages 46 – 47.
- 3 Perform "SHOWVIEW Setup" on page 10 to check if the Guide Program numbers have been set correctly.



**If auto channel set has succeeded but auto clock set has not:**

- 1 Perform "Video Channel Set" on page 8.
- 2 Turn on the TV and select its VIDEO channel or AV mode, then make sure that all necessary stations have been stored in the recorder's memory by using the **TV PROG.** button(s).
  - If station names (ID —  pg. 48) have also been stored in the recorder's memory, the station name will be displayed at the top left corner of the screen for about 5 seconds when the recorder is tuned to a different station.
  - If you want to set the tuner manually such as to add or skip channels, to change channel positions, or to set or change station names, see pages 46 – 47.
- 3 Perform "Clock Set" on page 49, then "SHOWVIEW Setup" on page 10 to check if the Guide Program numbers have been set correctly.

**If both auto channel set and auto clock set have failed:**

- 1 Make sure the TV aerial cable is connected properly to the recorder and turn off the recorder power once, then turn the recorder power back on again.
  - The Country Set display appears on the front display panel and/or on the screen; perform steps 2 and 4 on pages 4 – 5 again.

**IMPORTANT**

- Depending on the reception conditions, the station names may not be stored correctly, and auto Guide Program Number Set may not work properly. If the Guide Program numbers are not set properly, SHOWVIEW timer recording ( pg. 28) will not work correctly; be sure to check if the Guide Program numbers have been set correctly ( pg. 10, "SHOWVIEW Setup").
- Since your video recorder memorizes all detected stations even if the reception condition is poor, some of those stored stations may produce a noisy picture. To delete those stations,  "Delete A Channel" on page 46.

**INFORMATION****Language for the on-screen display**

Auto Set Up also selects the language automatically for the on-screen display depending on the Country setting you have made in step 2 on page 4 (unless you have selected BELGIUM or SUISSE), as shown below.

SUOMI	→ SUOMI	SVERIGE	→ SVENSKA	ESPAÑA	→ CASTELLANO
PORTUGAL	→ ENGLISH	DANMARK	→ DANSK	NEDERLAND	→ NEDERLANDS
DEUTSCHLAND	→ DEUTSCH	ÖSTERREICH	→ DEUTSCH	GREECE	→ ENGLISH
NORGE	→ NORSK	ITALIA	→ ITALIANO	OTHERS	→ ENGLISH

If you want to change the language setting manually,  "Language" on page 7.

**Just Clock**

Your recorder is equipped with the Just Clock function which provides accurate time keeping through automatic adjustments at regular intervals, by reading data from a PDC signal. If you want to take advantage of this function, simply set it to "ON".

 "Just Clock" on page 49.

# Language

- Be sure to set your Video Channel before performing Language setting (☞ pg. 8).
- Turn on the TV and select the VIDEO channel (or AV mode).

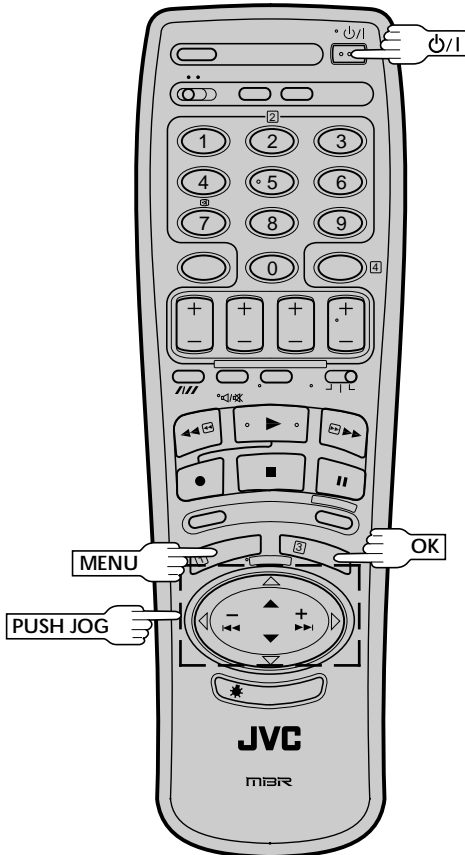

This recorder offers you the choice to view on-screen messages in 10 different languages. Though Auto Set Up selects the language automatically (☞ pg. 6), you can change the language setting manually using this procedure as required.

## 1 TURN ON THE RECORDER

Press **Power/1**.

## 2 ACCESS MAIN MENU

Press **MENU** twice.

## 3 ACCESS COUNTRY SET SCREEN

Press **PUSH JOG**  $\Delta$ / $\nabla$  to move the highlight bar (pointer) to "AUTO CH SET", then press **OK**.

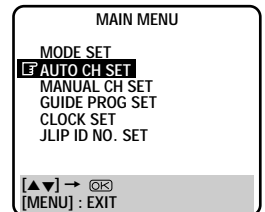

## 4 SELECT COUNTRY

Press **PUSH JOG**  $\Delta$ / $\nabla$  to move the highlight bar (pointer) to your country's name, then press **OK**. The Language Set screen appears.

## 5 SELECT LANGUAGE

Press **PUSH JOG**  $\Delta$ / $\nabla$  to move the highlight bar (pointer) to the language of your choice.

For HR-DD949EH



For HR-DD949EH



For HR-DD949E



\* The on-screen display differs for the HR-DD949EH depending upon the country in which the product was purchased.

- You do not have to press **OK**; pressing **OK** starts Auto Channel Set.

## 6 RETURN TO NORMAL SCREEN

Press **MENU**.

# Video Channel Set

Video Channel (RF Output Channel) is the channel on which your TV receives picture and sound signals from the video recorder through the RF cable.

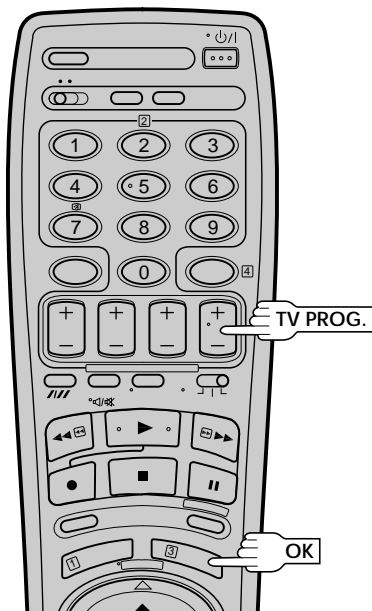
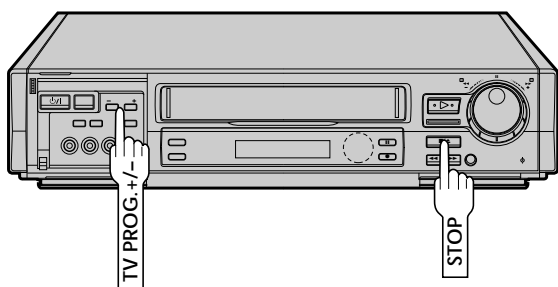

## TEST SIGNAL

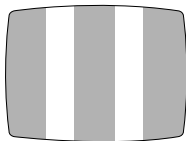

The channel on which the screen to the left appear clearly in step 2 is your Video Channel.

To view picture signals from the video recorder, set your TV to the Video Channel.

If you have connected the video recorder to your TV via the provided RF cable only (RF connection) – Go to "With RF Connection" below.

If you have connected the video recorder to your TV via both the provided RF cable and a 21-pin SCART cable (AV connection) – Go to "With AV Connection" on next page.

### IMPORTANT:

Before performing the following steps, make sure the recorder's power is off and there is no cassette inserted in the recorder.

## With RF Connection

### ACCESS VIDEO CHANNEL SET MODE

Hold down **STOP** on the recorder until the display panel shows the following.



### SET VIDEO CHANNEL

Set your TV to UHF channel 36.

- If the two vertical white bars appear clearly on the screen as shown in the illustration at bottom left, go to step 3.
- If the two vertical white bars do not appear clearly, press **TV PROG.**+ or – to set the video recorder to a vacant channel between 22 and 69 which is not occupied by any local station in your area.

(Ex.) If channel 50 is available in your area



Then set your TV to UHF channel 50 and check if the two vertical white bars appear clearly on the screen; if so, go to step 3. If not, re-set the video recorder to another vacant channel and try again.

### NOTES:

- If you set the video recorder to a channel which is occupied by a local station or has neighbouring channels that are occupied by local stations, the picture reception quality will be affected and some interference noise will appear on the TV screen. Be sure to select a vacant channel which has no broadcast on neighbouring channels.
- If you cannot obtain the two vertical white bars clearly with any channel between 22 and 69, consult your JVC dealer.

### EXIT VIDEO CHANNEL SET MODE

Press **OK**.

# 3

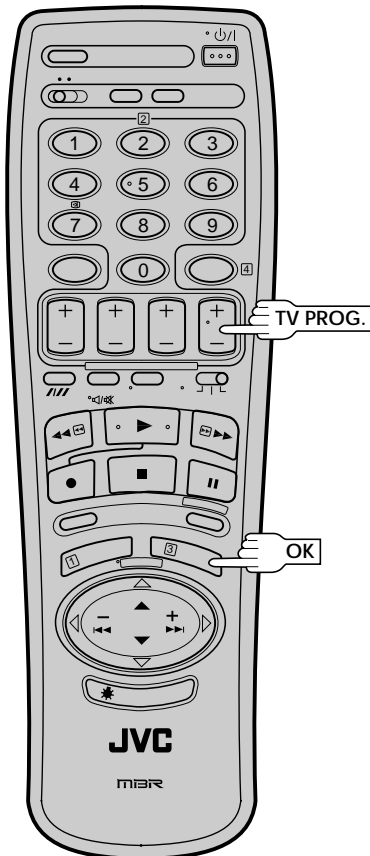
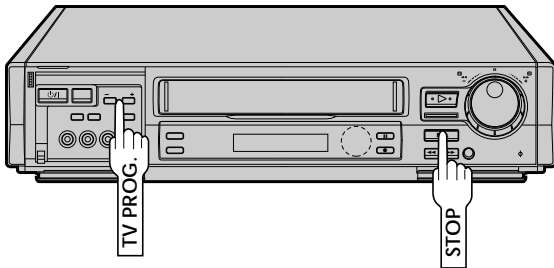

**IMPORTANT:**

Before performing the following steps, make sure the recorder's power is off and there is no cassette inserted in the recorder.

**With AV Connection****ACCESS VIDEO CHANNEL SET MODE****1**

Hold down **STOP** on the recorder until the display panel shows the following.

**SET VIDEO CHANNEL****2**

Press **TV PROG. -** until the display panel shows "-OUT--".



- Now the video channel is set to off.

**EXIT VIDEO CHANNEL SET MODE****3**

Press **OK**.

To view picture signals from the video recorder, set your TV to its AV mode.

# SHOWVIEW Setup

Turn on the TV and select the VIDEO channel (or AV mode).

\* For Customers in Australia and New Zealand:  
With this recorder, the G-Code system is identified as "SHOWVIEW".

With SHOWVIEW, timer programming is greatly simplified because each TV programme has a corresponding code number which your recorder is able to recognise.

**NOTE:**

"Guide Program (GUIDE PROG) Number" refers to the assigned TV station numbers, according to broadcast area, for SHOWVIEW timer recording.

**IMPORTANT**

Perform the following procedure after Auto Set Up on page 4 and/or the channel setting steps on pages 44 – 47, and after the Clock Set procedure on page 49.

After setting the Guide Program Numbers, the station names and channel positions may be incorrect if you stored or skipped channels. In this case, re-perform Guide Program Number setting.

## Guide Program Number Set

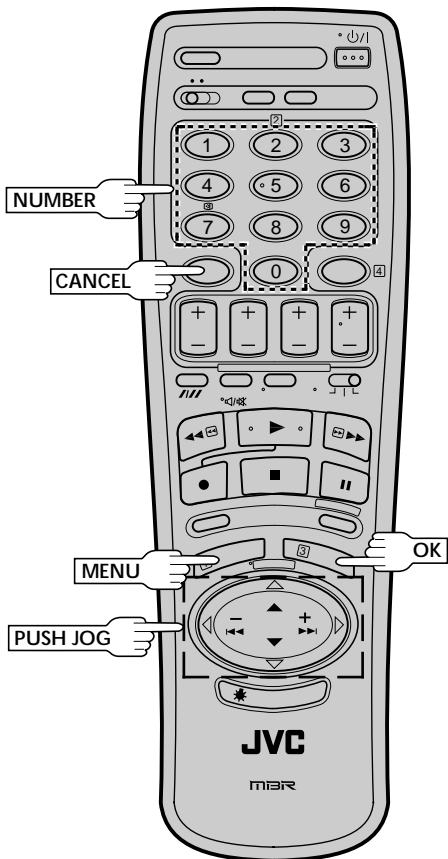

### 1 MAKE LIST OF STORED STATION NAMES AND CHANNEL POSITIONS

(Ex.)

Channel position	Station name
1	ARD
2	ZDF
3	WDR

### 2 ACCESS MAIN MENU SCREEN

Press **MENU** twice.

### 3 ACCESS GUIDE PROG SET SCREEN

Press **PUSH JOG**  $\Delta \nabla$  to move the highlight bar (pointer) to "GUIDE PROG SET", then press **OK**. The Guide Prog. Set screen appears.

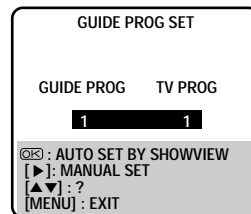
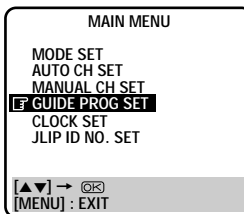

## ENTER SHOWVIEW NUMBER

4

Press **OK**, and a cursor appears above "GUIDE PROG". Then, using the **NUMBER** keys, input the **SHOWVIEW** number (found in most TV listings) of a program scheduled to be broadcast on each station on the list from step 1, starting at the top. If you enter the wrong number, press **CANCEL** to backspace and input the correct number.

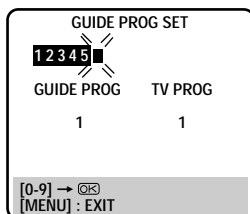

When entering a *SHOWVIEW* number for ZDF

## CONFIRM CHANNEL POSITION NUMBER

5

Press **OK** and the display under "TV PROG" begins blinking.

*If the blinking number under "TV PROG" agrees with the channel position . . .*

. . . press **OK**.

*If the numbers do not agree . . .*

. . . input the channel position using **PUSH JOG**▲▼ or the **NUMBER** keys, then press **OK**.

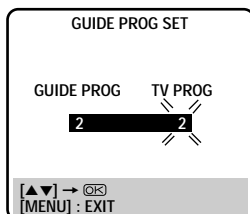

- If you input the **SHOWVIEW** number of a program that has already aired, "ERROR" appears on screen for a few seconds. Input the correct **SHOWVIEW** number.
- Repeat steps 4 and 5 as necessary.

## CLOSE MENU

6

Press **MENU** and selection is complete.

If you already know the Guide Program number for a station . . .

- 1- After step 3, press **PUSH JOG**▷.
  - The **GUIDE PROG** number begins blinking.
- 2- Enter the Guide Program number using the **NUMBER** keys or **PUSH JOG**▲▼, then press **PUSH JOG**▷.
  - The **TV PROG** number begins blinking.
- 3- Enter the channel position using the **NUMBER** keys or **PUSH JOG**▲▼, then press **PUSH JOG**◁.
  - Repeat 2 and 3 as necessary.
- 4- Press **MENU**.

## When Using A Satellite Tuner

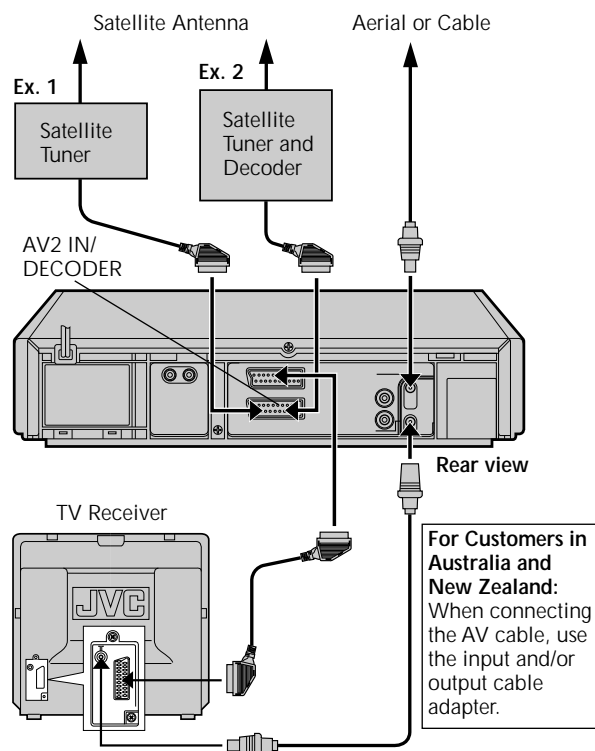

### Preparation

- 1- Connect the satellite tuner to the AV2 IN/DECODER connector on the rear of your recorder.
- 2- Set "AV2 SELECT" to "AV2" (☞ pg. 34).

### To Record Satellite Broadcasts . . .

- 1- Select the appropriate channel on the satellite tuner.
- 2- Press **NUMBER** key "0" to set your recorder's input mode to "AUX2".
- 3- Start recording (☞ pg. 21, steps 3 - 6).

### To Record Satellite Broadcasts Using SHOWVIEW Timer Recording . . .

- 1- Perform Guide Program Number setting.
  - In step 5 in the left column, press **NUMBER** key "0" to set "TV PROG" to "AUX2".
- 2- Perform **SHOWVIEW** Timer Recording (☞ pg. 28).

### To Record Satellite Broadcasts Using Regular Timer Recording . . .

- 1- In step 6 on page 31, press **TV PROG** +/- to set the channel position to "AUX2".

## NOTE:

When timer-recording a satellite programme, first set the satellite tuner to the appropriate channel before the selected programme begins and then set the satellite tuner's timer. If your satellite tuner does not have a timer, leave it switched on.

# Basic Playback

Turn on the TV and select the VIDEO channel (or AV mode).

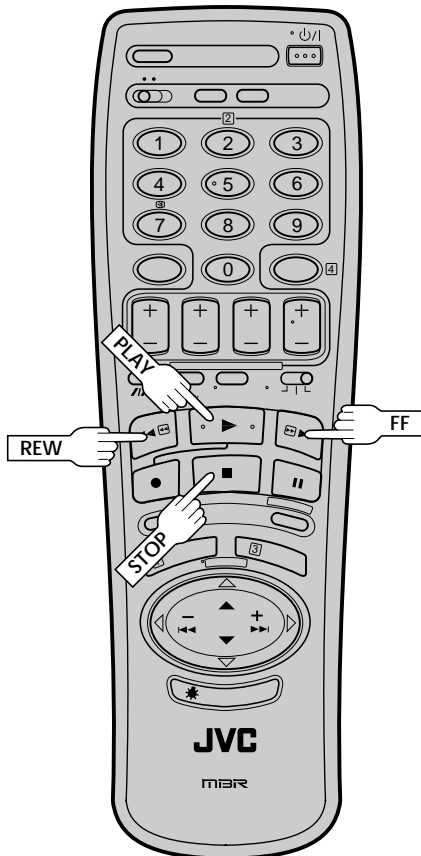
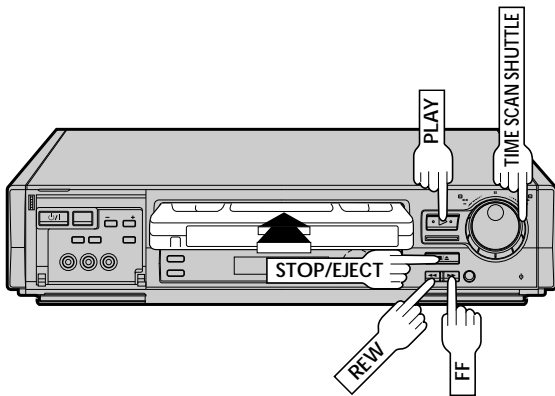

The easiest, most basic operation possible with your video recorder is tape playback. Already-recorded signals on a video tape are read by your video recorder and displayed on your TV just like a TV programme.

1

## LOAD A CASSETTE

Make sure the window side is up, the rear label side is facing you and the arrow on the front of the cassette is point toward the recorder. Don't apply too much pressure when inserting.

- The recorder power comes on automatically and the counter is reset to 0:00:00.
- If the record safety tab has been removed, playback begins automatically.

2

## FIND PROGRAMME START POINT

If the tape is advanced past the start point, press **REW** or turn the **TIME SCAN SHUTTLE** ring to the left. To go forward, press **FF** or turn the **TIME SCAN SHUTTLE** ring to the right.

3

## START PLAYBACK

Press **PLAY**. "BEST" appears blinking in the recorder's display panel during automatic tracking. (☞ pg. 22)

4

## STOP PLAYBACK

Press **STOP** on the remote or **STOP/EJECT** on the recorder's front panel. Then press **STOP/EJECT** to remove the cassette.

### Usable cassettes

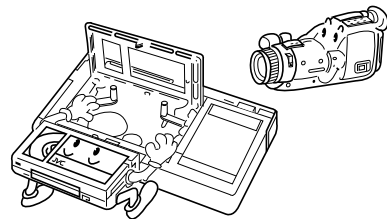

- Compact VHS camcorder recordings can be played on this video recorder. Simply place the recorded cassette into a VHS Cassette Adapter and it can be used just like any full-sized VHS cassette.
- This video recorder can record on regular VHS and Super VHS cassettes. However, it will record and play back regular VHS signals only. It is not possible to play back a recorded Super VHS tape.

# Playback Features

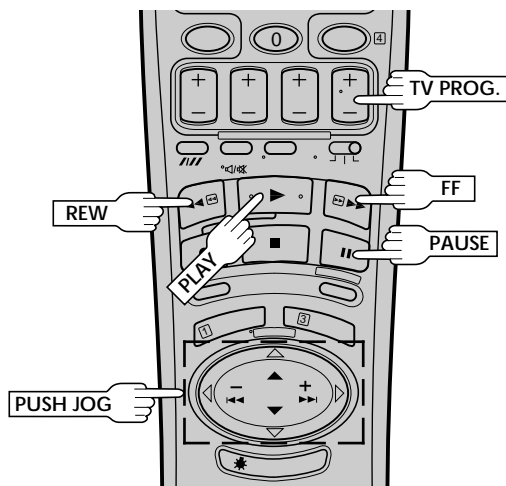
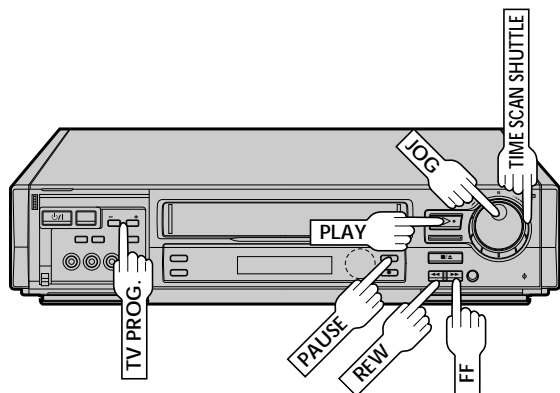

## High-Speed (Turbo) Search

1

### ACTIVATE HIGH-SPEED SEARCH

During playback or still picture, press **FF** for forward high-speed search, or **REW** for reverse high-speed search.

To resume normal playback, press **PLAY**.

### NOTES:

- For short searches, press and hold **FF** or **REW** for over 2 seconds. When released, normal playback resumes.
- Picture may not appear during search with an LP-recorded tape.
- In the search, still, or frame by frame playback mode, the picture may be distorted, and there may be a loss of colour.

Take advantage of special functions possible with the recorder's controls or the remote control.

## Still Picture/Frame-By-Frame Playback

1

### PAUSE DURING PLAYBACK

Press **PAUSE**. If there is vertical jitter, use the **TV PROG.** buttons to correct the picture.

- During still picture, the sound from the previous 3 seconds (approx.) will be played back repeatedly (provided there was at least 6 seconds of normal playback prior to engaging the still picture mode). However, the **TIME SCAN** indicator will not light.
- "TIME SCAN AUDIO" must be set to "ON", or the sound will not be heard. (☞ pg. 20)

2

### ACTIVATE FRAME-BY-FRAME PLAYBACK

Turn the **JOG** dial to the right for forward frame-by-frame playback, or to the left for reverse frame-by-frame playback.

**OR**

Press **PAUSE**.

**OR**

Press **PUSH JOG** < or >.

To resume normal playback, press **PLAY**.

## Slow Motion

1

### ACTIVATE SLOW-MOTION PLAYBACK

Turn the **TIME SCAN SHUTTLE** ring to the left or press **PUSH JOG** < during playback to decrease speed in the forward direction. To play in reverse slow-motion (and in reverse play mode), continue to turn the **TIME SCAN SHUTTLE** ring to the left or press **PUSH JOG** < after selecting all the forward direction slow-motion modes.

**OR**

During still picture, turn the **TIME SCAN SHUTTLE** ring to the right for forward slow motion, or to the left for reverse slow motion.

**OR**

During still picture, press and hold **PAUSE** for 2 seconds, then release. Press and release again to return to still picture.

**OR**

During still picture, press and hold **PUSH JOG** < or >. Release to return to still picture.

To resume normal playback, press **PLAY**.

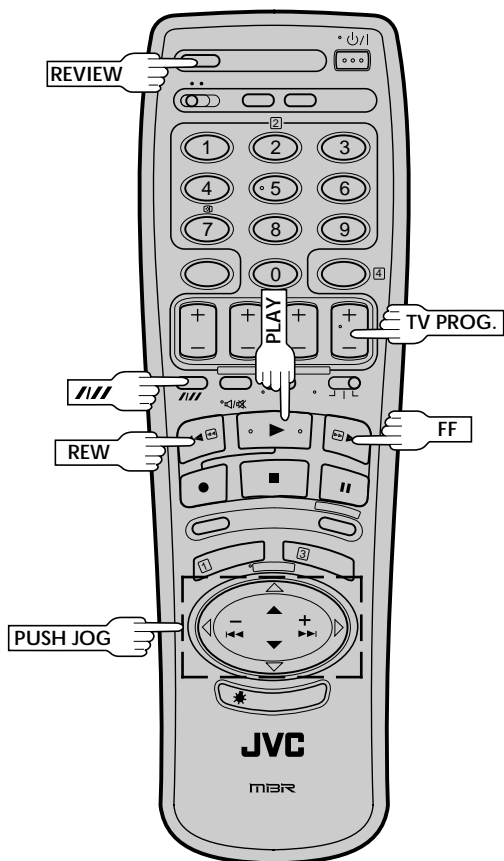
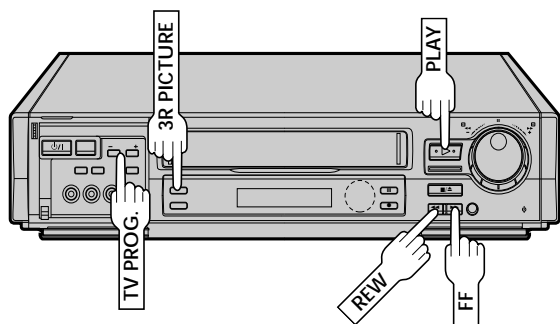

## Manual Tracking

Your video recorder is equipped with automatic tracking control. During playback, you can override this and adjust the tracking manually by pressing the **TV PROG.** buttons.

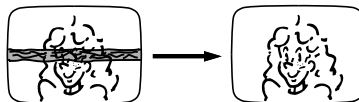

### 1 OVERRIDE AUTOMATIC TRACKING

Press **SP/LP (//)** on the remote to engage manual tracking.

### 2 ADJUST TRACKING MANUALLY

Press **TV PROG. +** or **-** to adjust tracking.

### 3 RETURN TO AUTOMATIC TRACKING

Press **SP/LP (//)** on the remote to re-engage automatic tracking.

#### NOTE:

When a new tape is inserted, the recorder enters the automatic tracking mode automatically.

## 3R Picture

3R(= Resolution and Response Recovery technology) maximises sense of resolution and sharpens image edges to make playback picture look better focused.

### 1 ACTIVATE 3R PICTURE

Press **3R PICTURE**. The button will light.

- To turn off 3R Picture, press **3R PICTURE** again so that the light goes off.
- Normally it is recommendable to keep 3R Picture ON (with the button lit).
- Depending on the type of tape used, picture quality may be better with 3R Picture set to off.
- If you use this recorder as the player for editing, be sure to turn off 3R Picture before starting.
- The setting will remain effective even though you turn on/off the recorder.

## Information On Colour System

You can also record SECAM signals, or play back a MESECAM tape on this recorder. When a MESECAM tape is played back, "MESECAM" appears on the screen for about 5 seconds. MESECAM is the designation for tapes with SECAM signals that have been recorded on a MESECAM-compatible PAL video recorder.

## Index Search

Your recorder automatically marks index codes at the beginning of each recording. This function gives you quick access to any one of 9 index codes in either direction.

### NOTE:

Before starting, make sure the recorder is in the Stop mode.



1

## ACTIVATE INDEX SEARCH

Press **PUSH JOG** < or > (◀◀ or ▶▶). "◀◀ 1" or "▶▶ 1" is displayed on screen and search begins in the corresponding direction.

- To access index codes 2 through 9, press **PUSH JOG** < or > repeatedly until the correct index number is displayed.

Ex.: To locate the beginning of B from the current position, press **PUSH JOG** < twice.  
To locate the beginning of D from the current position, press **PUSH JOG** > once.

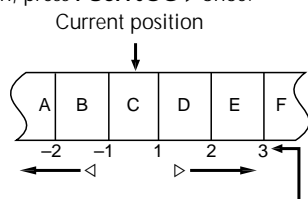

Index number

- When the specified index code is located, playback begins automatically.

## Instant ReView

Simply by pressing a single button, the recorder power comes on, rewinds, and begins playback of the last timer-recorded programme. If you have several programmes recorded, you can easily access any of them.

### NOTE:

Before starting, make sure that the recorder is off and that the Timer mode is disengaged.

1

## ACTIVATE INSTANT REVIEW

Press **REVIEW**. The recorder power comes on and the recorder searches for the index code indicating the start of the last timer-recorded programme. Once it's found, playback begins automatically.

The front display panel tells you how many programmes have been recorded. If you have, for example, 3 programmes, "REVIEW" and "3" appear and blink. To watch the first of the 3 programmes, press **REVIEW** three times. The recorder searches and begins playback automatically. You can access a programme as far as 9 index codes away from the current tape position.

### NOTE:

Instant ReView is not possible while the recorder is in the Timer mode.

## NTSC Playback

Your video recorder is equipped with NTSC circuitry that can play back NTSC tapes.

1

## LOAD A CASSETTE

Insert a cassette recorded in NTSC.

2

## START PLAYBACK

Press **PLAY**.

- "NTSC" appears on the screen for about 5 seconds.
- Some TVs shrink the picture vertically and place black bars at the top and bottom of the screen. This is not a malfunction on the part of either the video recorder or the TV.
- The picture may roll up and down. This can be corrected using the V-HOLD control found on some TVs. (This cannot be corrected if the TV does not have a V-HOLD control.)
- The counter and tape remaining time readings will be incorrect.
- During search, still, or frame-by-frame playback, the picture will be distorted, and there may be a loss of colour.
- Depending on the type of TV, the top and bottom portions of superimposed displays may be cut off during NTSC playback.

## Tape Position Indicator

The tape position indicator appears on screen when, from the Stop mode, you press **FF**, **REW** or perform an Index Search. The position of "■" in relation to "0" (beginning) or "+" (end) shows you where you are on the tape.

"O.S.D." (pg. 24) must be set to "ON", or the indicator will not appear.

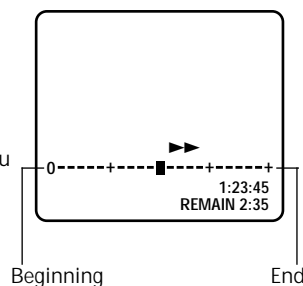

### NOTE:

Depending on the type of tape used, there may be times when the indication is not correct.

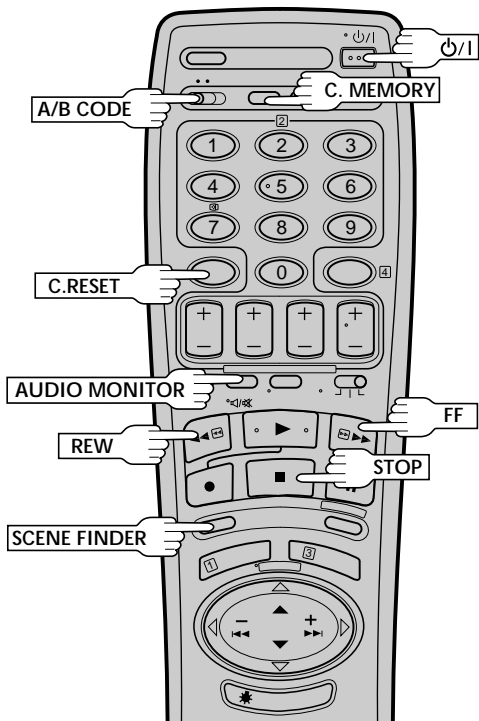
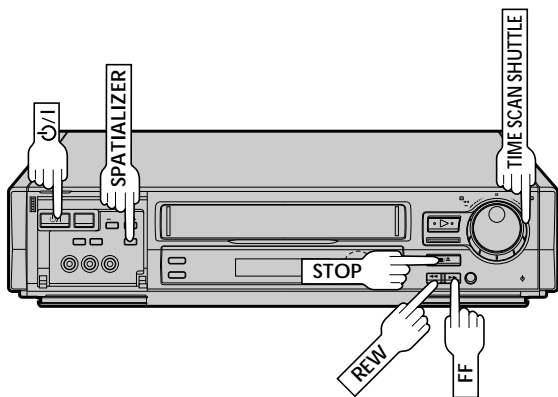

## Spatializer®

This feature expands sound field when you play back any stereo source or view a stereo programme while recording it.  
\*Spatializer® has no effect on recording quality.

### 1 ACTIVATE SPATIALIZER®

Press **SPATIALIZER**; the current setting will be displayed on the screen for about 5 seconds. Pressing **SPATIALIZER** while the screen shows the display changes the setting.

- To view a stereo programme such as movies or music, select "SPATIALIZER [Speaker Icon]" to create more spacious sound.
- To view a monaural programme, select "SPATIALIZER→ST" which simulates a stereo effect.
- Select "SPATIALIZER OFF" to turn off Spatializer® if the sound becomes unnatural with either "SPATIALIZER [Speaker Icon]" or "SPATIALIZER→ST" selected.
- If your TV is equipped with 3D-PHONIC and if you use both Spatializer® and 3D-PHONIC at the same time, the sound may become unnatural; set either function to "OFF".
- The setting will remain effective even though you turn on/off the recorder.

### NOTES:

- Spatializer® is effective only with a stereo TV.
- The setting cannot be changed during search, still, frame-by-frame playback or slow motion mode.
- When this recorder is used as the player for editing, the recorded audio will correspond to the Spatializer® setting.

## Soundtrack Selection

Your video recorder is capable of recording three soundtracks (HI-FI L, HI-FI R and NORM) and will play back the one you select.

### During Playback

Pressing **AUDIO MONITOR** on the remote control changes the soundtrack being played back as follows:

TRACK		USE
Recorder's Front Panel	On-Screen Display	
L + R	HI FI L [Speaker Icon] R	For Hi-Fi stereo tapes
L	HI FI L [Speaker Icon]	For main audio of Bilingual tapes
R	HI FI [Speaker Icon] R	For sub audio of Bilingual tapes
NORM	NORM	For audio-dubbed tapes
L + R + NORM	HI FI NORM	For audio-dubbed tapes

### NOTES:

- "L + R" should normally be selected. In this mode, Hi-Fi stereo tapes are played back in stereo, and the normal audio track is played back automatically for tapes with only normal audio.
- For instructions on recording stereo and bilingual programmes, refer to page 26.
- "O.S.D." must be set to "ON" or the on-screen displays will not appear (pg. 24).



## Scene Finder

This function helps you check contents of unlabeled recorded tapes at the touch of a single button.

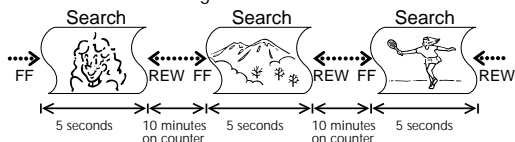

### NOTE:

Scene Finder cannot be used when the recorder is in the Record mode.

1

## ACTIVATE SCENE FINDER

Press **SCENE FINDER**. The recorder starts forward search for 5 seconds and then fast-forwards 10 minutes on the counter. This cycle is repeated until the end of the tape is reached.

- To start Scene Finder in the reverse direction, press **SCENE FINDER** and then press the **REW** button within 2 seconds. This cycle is repeated until the beginning of the tape.
- During Scene Finder, the following indications appear on the display panel:



2

## STOP SCENE FINDER

Press **STOP**.

### NOTES:

- During Scene Finder search, you can also hear the tape sound. During fast forward or rewind, you hear the current TV sound instead.
- During Scene Finder, the sound can be heard regardless of "TIME SCAN AUDIO" setting. pg. 20.
- Scene Finder does not function during Index Search.

## Next Function Memory

You can set your recorder's power to go off automatically after the tape is fully rewound. Before starting, make sure the recorder is in the Stop mode.

For Automatic Power Off After Tape Rewind . . .  
 . . . press **REW**, then press **⏪/I** within 2 seconds.

### NOTE:

If you want the power to be turned off automatically when the counter reads "0:00:00" (instead of at the beginning of the tape), press **C.MEMORY** so that the "M" mark appears before pressing **REW**.

## Remote A/B Code Switching

The remote control is capable of controlling two JVC video recorders independently; one set to respond to the remote control's A code control signals and another set to respond to B code control signals. The remote control is preset to send A code signals because your video recorder is initially set to respond to A code signals. You can easily modify your video recorder to respond to B code signals.

1

## REMOVE POWER SUPPLY

Unplug the mains power cord from the mains outlet.

2

## SET A/B CODE SWITCH

Set to B.

3

## RE-SUPPLY POWER

Plug the mains power cord back into the mains outlet.

4

## TURN THE RECORDER ON

Press **⏪/I** on the remote control. The recorder will now only respond to B code signals.

### NOTE:

Some TV sets may malfunction in response to the B mode. If this happens, switch back to the A mode.

## Counter Memory

Returns to the counter reading of "0:00:00" to conveniently find a specific place on the tape automatically.

1

## SET COUNTER MEMORY

Press **C. RESET** during playback at a point you wish to locate later. The counter reads "0:00:00". Then press **C.MEMORY**, and "M" appears in front of the counter digits.

2

## ACTIVATE COUNTER MEMORY

When you wish to return to the designated point, press **STOP** and then **REW** or **FF**.

- The tape rewinds or fast-forwards and stops at about 0:00:00 automatically.
- To cancel Counter Memory, press **C.MEMORY** again.

# TimeScan

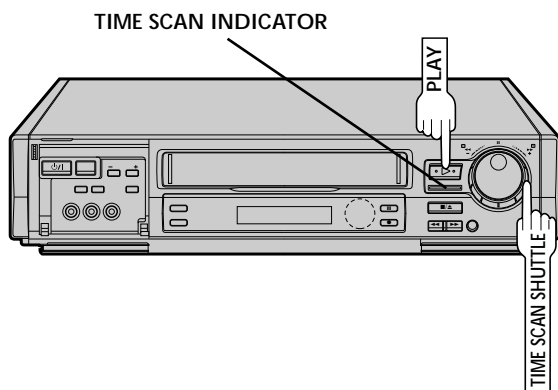

Your recorder is equipped with the TimeScan function. TimeScan allows noise free pictures to be displayed on your TV screen in the forward and reverse search modes. Audio will be played back at normal speed during any of the TimeScan modes (☞ pg. 19). TimeScan allows you to view a program in search mode while listening to the audio.

## NOTES:

- "TIME SCAN AUDIO" must be set to "ON", or the sound will not be heard in TimeScan mode. (☞ pg. 19)
- The audio will not synchronize with the video in TimeScan modes.
- In Pause mode 3 seconds (approx.) of audio will be played back repeatedly. (☞ pg. 13)
- In TimeScan search modes some of the audio information will not be played so that the audio can keep up with the video.

### Audio signal during TimeScan

Playback tape

1	2	3	4	5
---	---	---	---	---

Sound of 1, 3 and 5 is heard.

Sound of 2 and 4 is not heard.

Output audio signal is normal (monaural) sound.

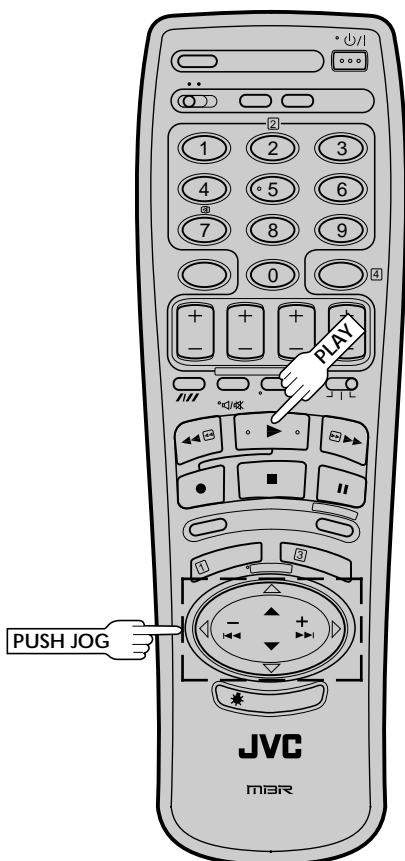

## Variable-Speed Search/ Reverse Play

### ACTIVATE VARIABLE-SPEED SEARCH

# 1

During playback or still, turn the recorder's **TIME SCAN SHUTTLE** ring. It remains at that position even after you release it. Each time it passes a click position, the playback speed changes. (Refer to the chart on pg 19 for playback speeds).

### OR

During playback, press **PUSH JOG** ◀ or ▶.

- The more times you press, the faster the playback picture moves.
- To decrease speed, press the button for the opposite direction. (Refer to the chart on pg 19 for playback speeds).

To resume normal playback, press **PLAY**.

## TimeScan

Names of special-effects playback	Reverse				Forward			
	Search	Play	Slow-Motion	*Still	Slow-Motion	Play	Search	
Speed SP	-9x   -7x   -5x   -3x	-1x	-1/6x   -1/18x	0	1/18x   1/6x	1x	2x   3x   5x   7x   9x	
Speed LP	-7x   -3x		-1/6x   -1/18x	0	1/18x   1/6x	1x	2x   5x   9x	
Audio output	Audio is output.		Audio is not output.	Audio is output.	Audio is not output.	Audio is output.		

\* Still mode cannot be engaged using the remote control's **PUSH JOG** button. In the Still mode, the TIME SCAN indicator does not light even though you can hear TimeScan audio.

- The VCR's TimeScan indicator lights during TimeScan.
- The speed is shown during TimeScan in the upper right corner of the TV screen for approx. 5 seconds. (The display may be distorted.)
- To resume normal playback, press **PLAY**.
- When using the recorder's **TIME SCAN SHUTTLE** ring, the playback speed may not change depending on how far it is turned.
- Picture and audio may become distorted when the recording speed changes. When this happens, resume normal playback once, and then try using TimeScan again.
- The picture may be noisy or there may be a loss of colour when you change the playback speed. (More noise will appear with LP recordings.)
- Noise may appear or the upper part of the picture may be distorted during still, frame-by-frame playback, 2x search of LP recordings, or depending on the tape being used.
- Picture may appear distorted in comparison to normal playback.
- In TimeScan mode there will be a time lag between the video and the audio and noise may appear in the audio signal.
- TimeScan sound quality will differ in comparison to normal playback.
- When the playback direction is reversed, it takes approximately 6 seconds until sound is heard.
- TimeScan does not work with NTSC playback. Picture will be monochrome with an LP-recorded MESECAM tape during TimeScan.

*If you don't want to hear TimeScan audio, set "TIME SCAN AUDIO" to "OFF" (🔊 pg. 20).*

## TimeScan Audio

The audio output can be set ON/OFF during TimeScan. Select ON/OFF as required.

\* The default setting is "ON".

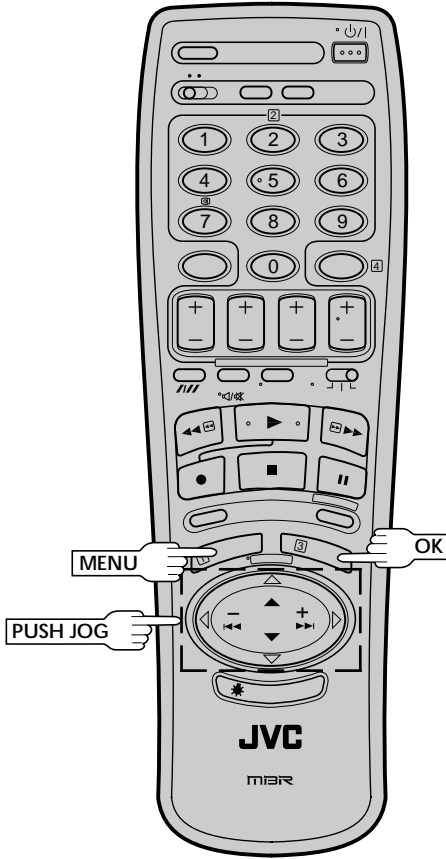

### 1 ACCESS MAIN MENU SCREEN

Press **MENU** twice.

### 2 ACCESS MODE SET SCREEN

Move the highlight bar (pointer) to "MODE SET" by pressing **PUSH JOG**  $\Delta \nabla$ , then press **OK**.

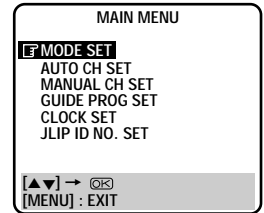

### 3 SELECT MODE

Move the highlight (pointer) to "TIME SCAN AUDIO" by pressing **PUSH JOG**  $\Delta \nabla$ , then press **PUSH JOG**  $\triangleright$  to select "ON" or "OFF".

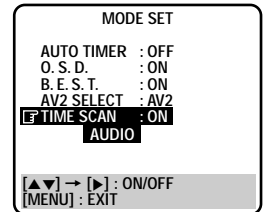

### 4 RETURN TO NORMAL SCREEN

Press **MENU**.

# Basic Recording

Turn on the TV and select the VIDEO channel (or AV mode).

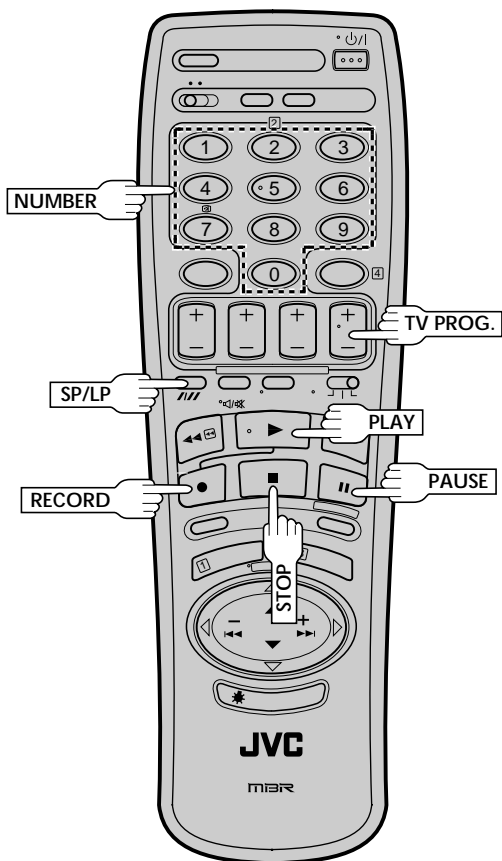
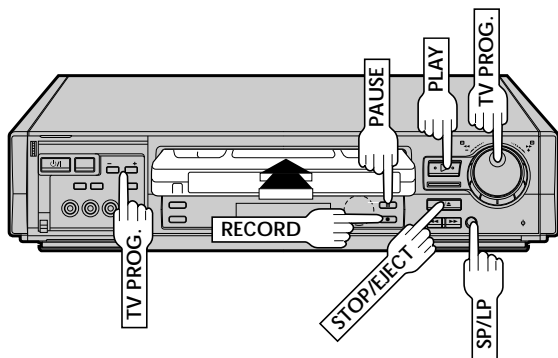

TV signals being received by the recorder's built-in tuner can be recorded onto a video tape. You can "capture" a TV programme using your video recorder.

1

## LOAD A CASSETTE

Insert a cassette with the record safety tab intact.

- The counter is reset to 0:00:00 and the recorder power comes on automatically.

2

## CHOOSE A PROGRAMME

Press **TV PROG. +/-** or the **NUMBER** keys to select the channel you wish to record.

- The **TV PROG.** dial can also be used to select a channel.

3

## SET TAPE SPEED

Press **SP/LP (//)**. Check the SP/LP indicator on the recorder display panel to confirm the selected tape speed.

4

## START RECORDING

Press and hold **RECORD** and **PLAY** on the remote control, or press **RECORD** on the recorder.

B.E.S.T. takes place at the beginning of both the first SP and the first LP recording after inserting the cassette (pg. 22).

5

## PAUSE/RESUME RECORDING

Press **PAUSE**. Press **PLAY** to resume recording.

6

## STOP RECORDING

Press **STOP** on the remote control or **STOP/EJECT** on the recorder. Then press **STOP/EJECT** to remove the cassette.

### Accidental erasure prevention

- To prevent accidental recording on a recorded cassette, remove its safety tab. To record on it later, cover the hole with adhesive tape.

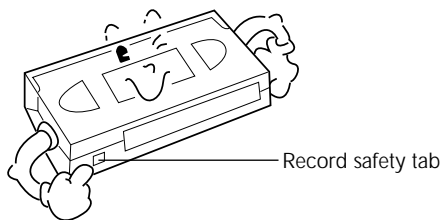

# B.E.S.T. Picture System

Turn on the TV and select the VIDEO channel (or AV mode).

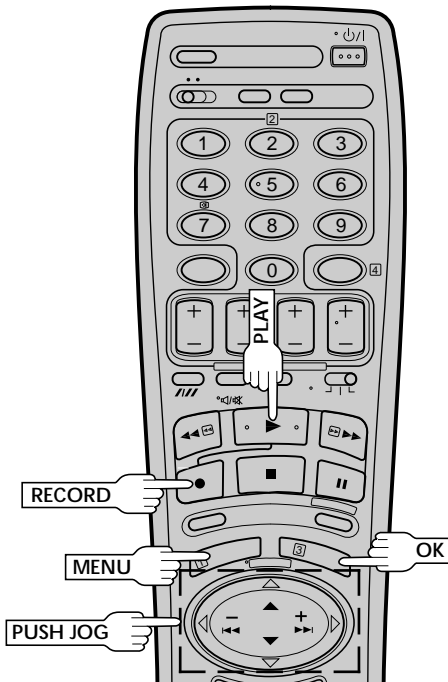
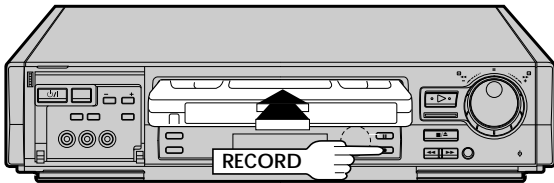

## Display Panel Indication



As the tape check progresses, the "--" marks on the display panel increase upward. Once the "BEST" indicator starts blinking, the check is complete.

The B.E.S.T. (Biconditional Equalised Signal Tracking) system checks the condition of the tape in use during recording and playback, and compensates to provide the highest-possible recording and playback pictures. The default setting for both recording and playback is "ON".

## Recording

### 1 LOAD A CASSETTE

Insert a cassette with the record safety tab intact.

- The recorder power comes on automatically.

### 2 ACCESS MAIN MENU SCREEN

Press **MENU** twice.

### 3 ACCESS MODE SET SCREEN

Move the highlight bar (pointer) to "MODE SET" by pressing **PUSH JOG**  $\Delta \nabla$ , then press **OK**.

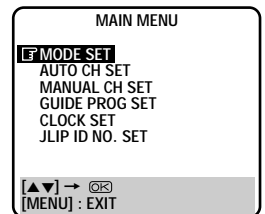

### 4 CONFIRM B.E.S.T. STATUS

The default setting is "ON". If this is the case, go to step 5. If not, press **PUSH JOG**  $\nabla$  to move the highlight bar (pointer) to "B.E.S.T.", then press **PUSH JOG**  $\triangleright$  to set to "ON".

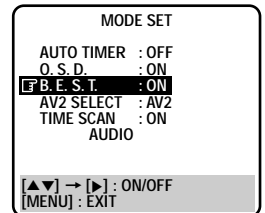

### 5 RETURN TO NORMAL SCREEN

Press **MENU**.

### 6 START RECORDING

Press and hold **RECORD** and **PLAY** on the remote, or press **RECORD** on the recorder.

- The recorder spends approximately 7 seconds assessing the condition of the tape, then begins recording.
- When the "BEST" indicator begins blinking, that means adjustment is complete.
- Pressing the recorder's **RECORD** button while "BEST" is displayed does not start Instant Timer Recording (see pg. 27).

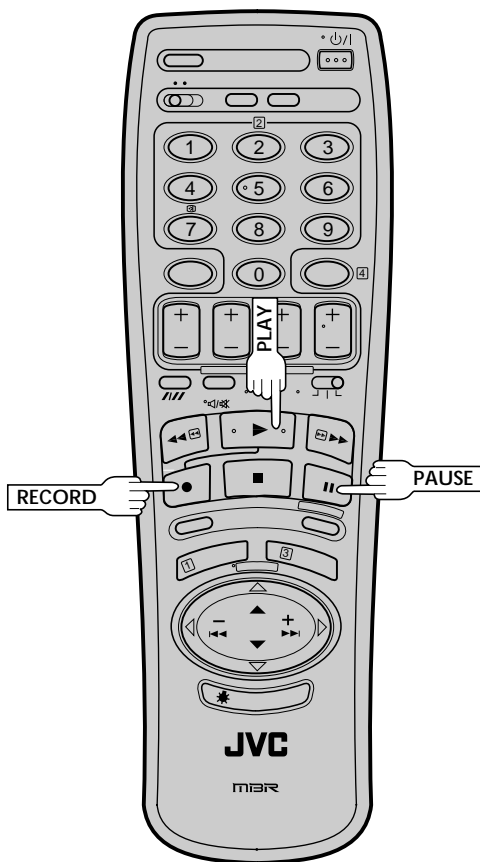
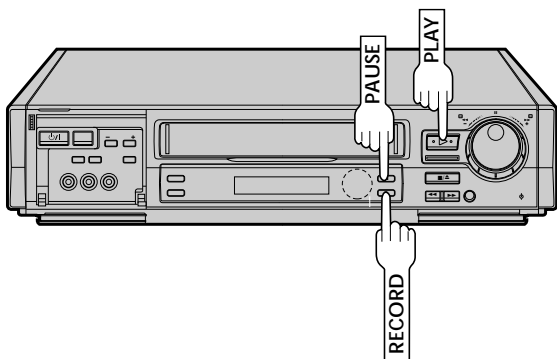

## NOTES:

- The B.E.S.T. system works for both SP and LP modes only after a tape has been inserted and the Record mode is first initiated. It does not work during recording.
- In the case of timer recording, the B.E.S.T. system works before recording is initiated.
- Once the cassette is ejected, the B.E.S.T. data is cancelled. The next time the cassette is used for recording, B.E.S.T. is re-performed.

## ATTENTION:

Since the B.E.S.T. system works before recording actually starts, there is a delay of approximately 7 seconds after **RECORD** and **PLAY** on the remote are pressed, or **RECORD** on the recorder is pressed. To make sure you record the desired scene or programme in its entirety, first perform the following steps:

- 1) Press and hold **PAUSE** and **RECORD** to engage the RECORD PAUSE mode.
  - The recorder then automatically checks the condition of the tape and, after approximately 7 seconds, re-enters RECORD PAUSE.
- 2) Press **PLAY** to start recording.
  - If you want to bypass the B.E.S.T. system and begin recording immediately, set "B.E.S.T." to "OFF" in step 4 on page 22.

## Playback

The recorder assesses the quality of the tape once you initiate playback.

When watching a tape recorded with "B.E.S.T." set to "ON", it is recommended that you leave B.E.S.T. on during playback as well.

## START PLAYBACK

# 1

Press **PLAY**.



- The recorder adjusts the playback picture quality based on the quality of the tape in use.
- B.E.S.T. is active during Auto Tracking. "BEST" appears blinking on the recorder's display panel.

## NOTES:

- When watching a rental tape or one recorded on another video recorder, or when using this recorder as the player for editing, set B.E.S.T. to your preference by performing steps 2 through 5 on page 22.
- "BEST" only appears at the beginning of automatic tracking. Even though it doesn't appear after that, the B.E.S.T. function is operative.





# Recording Features

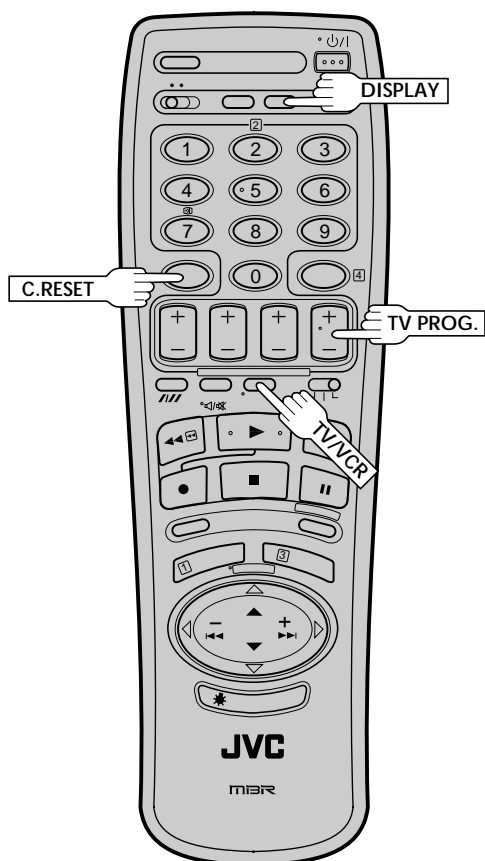
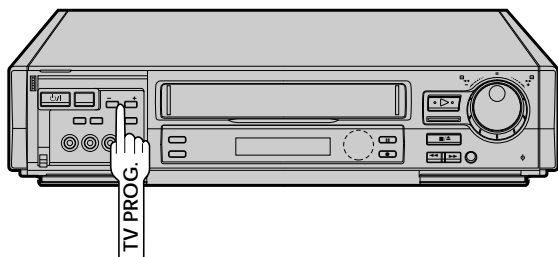

## Record One Programme While Watching Another

If your recorder is connected to the TV via AV connection, . . . . . press **TV/VCR**. The recorder's VCR indicator and the TV broadcast being recorded disappear.

### 1 SELECT CHANNEL TO WATCH

Once recording is in progress, all you need to do is to set the channel controls on the TV for the station you wish to view.

- The programme selected with the TV's channel controls appears on the TV screen while the one selected with the recorder's **TV PROG.** buttons is recorded on the tape.
- If a decoder is connected to the recorder (see pg. 41), you can select a scrambled channel as well with the TV channel controls.

## Elapsed Recording Time Indication

You can check the exact time of a recording.

### 1 SET COUNTER DISPLAY

Press **DISPLAY** until a counter reading appears on the display panel.

### 2 RESET COUNTER

Press **C. RESET** before starting recording or playback.

- The counter is reset to "0:00:00" and shows the exact elapsed time as the tape runs.

## Tape Remaining Time

### 1 DISPLAY REMAINING TIME

Press **DISPLAY** until the time remaining on the tape appears.

- By pressing the **DISPLAY** button, you can change the display to show the counter reading, channel position\*, clock time or tape remaining time.  
\* channel position is not displayed during playback.

### NOTE:

Depending on the type of tape used, there may be times when the tape remaining time reading may not appear right away, or is not correct. "- : -" may sometimes appear, or the display may blink on occasion.

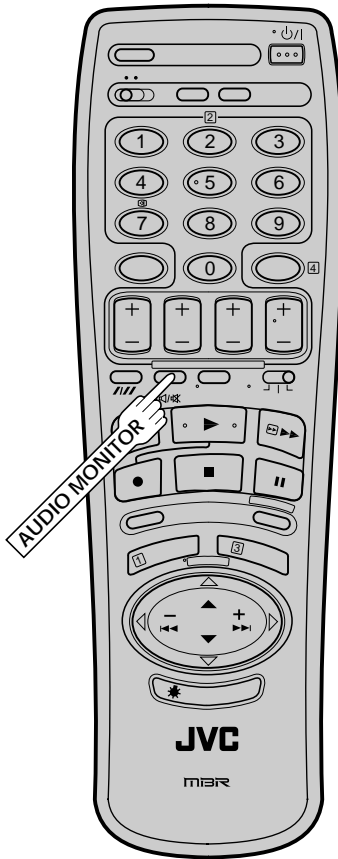

## Receiving Stereo And Bilingual Programmes

Your recorder is equipped with a Sound-Multiplex decoder (A2) and, if you own the HR-DD949EH, a Digital stereo sound decoder (NICAM) as well, making reception of stereo and bilingual broadcasts possible.

When the channel is changed, the type of broadcast being received will be displayed on the TV screen for a few seconds.

Type of Broadcast Being Received	On-screen Display
A2 Stereo	ST
A2 Bilingual	BIL
Regular Monaural	(none)
*NICAM Stereo	ST NICAM
*NICAM Bilingual	BIL NICAM
*NICAM Monaural	NICAM

\*Available with HR-DD949EH only.

- To listen to a stereo programme, press **AUDIO MONITOR** until "L" and "R" appear on the front display panel.
- To listen to a bilingual programme, press **AUDIO MONITOR** until either "L" or "R" appears on the front display panel (as required).
- To listen to the Standard (regular monaural) audio while receiving a NICAM broadcast, press **AUDIO MONITOR** until "NORM" appears on the front display panel. (HR-DD949EH only)

### NOTE:

"O.S.D." must be set to "ON" or the on-screen displays will not appear (☞ pg. 24).

## To Record Stereo And Bilingual Programmes (A2)

- Stereo programmes are automatically recorded in stereo on the Hi-Fi audio track (with the normal audio track recording mixed L and R channel sound).
- Bilingual programmes are automatically recorded in bilingual on the Hi-Fi audio track. The main soundtrack will be recorded on the normal audio track.

### NOTES:

- If the quality of stereo sound being received is poor, the broadcast will be received in monaural with better quality.
- Before playing back a programme recorded in stereo, or a bilingual programme, refer to "Soundtrack Selection" (☞ pg. 16).

## To Record NICAM Stereo And Bilingual Programmes (HR-DD949EH only)

- The NICAM audio programme will be recorded on the Hi-Fi audio track, and the Standard audio programme on the normal audio track.

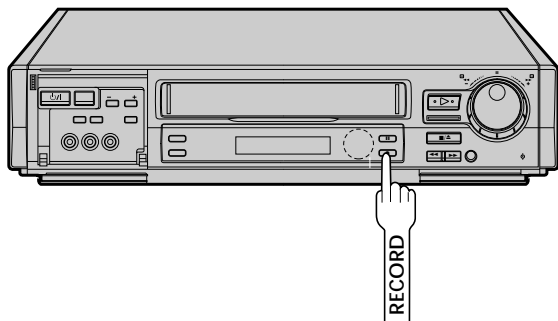

## Instant Timer Recording (ITR)

This easy method lets you record for from 30 minutes to 6 hours (selectable in 30-min. increments), and shuts the recorder off after recording is finished.

### 1 START RECORDING

Press **RECORD** on the recorder.

### 2 ENGAGE ITR MODE

Press **RECORD** again. "O" blinks and 0:30 appears on the front display panel.

### 3 SET RECORDING DURATION

If you want to record for more than 30 minutes, press **RECORD** to extend the time. Each press extends recording time by 30 minutes.

### NOTE:

*You can only perform ITR using the **RECORD** button on the recorder's front panel.*

# SHOWVIEW Timer Recording

Before performing SHOWVIEW timer recording:

- Be sure to read "SHOWVIEW Setup" (pg. 10).
- Insert a cassette with the safety tab in place. The recorder will come on automatically.
- Turn on the TV and select the VIDEO channel (or AV mode).

**\* For Customers in Australia and New Zealand:**

With this recorder, the G-Code system is identified as "SHOWVIEW".

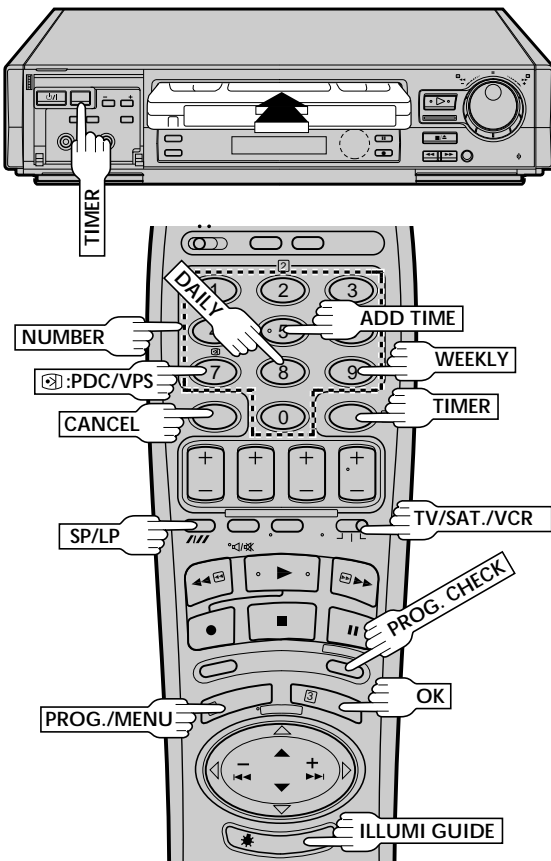

### When Using The Illumi-Guide Feature

- Buttons light or blink on the remote control for approximately 10 seconds. If the button or buttons extinguish during timer programming, press **ILLUMI GUIDE** and the button or buttons previously lit or blinking come back on. If the button or buttons do not re-light or start blinking again, press **MENU** and re-perform the timer programming procedure from the beginning.
- If for some reason the remote control's signal is not received by the video recorder, press **MENU** and re-perform the timer programming procedure from the beginning.

During SHOWVIEW and regular timer programming, the Illumi-Guide feature tells you which button on the remote control must be pressed next by lighting it up. To use this feature, with the **TV/SAT./VCR** switch set to "VCR", press **ILLUMI GUIDE** before performing step 1. (**PROG.**, **REW**, **PLAY**, **FF** light up at this time.)

If you aren't going to use the Illumi-Guide feature, go directly to step 1.

## 1 ACCESS TIMER PROGRAMMING SCREEN

Press **PROG.**

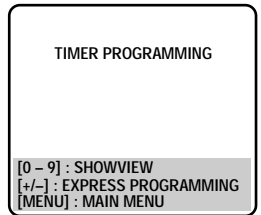

The front display panel looks like this:



- If you are using the Illumi-Guide feature, the following buttons will light up: **NUMBER** keys (0-9), **START +/-**, **STOP +/-**, **DATE +/-**, **TV PROG. +/-**, **MENU** and **CANCEL**.

## 2 ENTER SHOWVIEW NUMBER

Press the **NUMBER** keys to enter the SHOWVIEW number of a programme you wish to record.

- If you make a mistake, press **CANCEL** to backspace and then input the correct number.

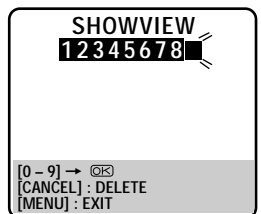

The SHOWVIEW number you enter appears on the front display panel:



The display panel can only show 4 digits at a time.

- If you are using the Illumi-Guide feature, **OK** blinks when the following buttons are lit: **NUMBER** keys (0-9), **CANCEL** and **MENU**.

### ATTENTION:

SHOWVIEW Timer Programming cannot be performed correctly for programmes whose SHOWVIEW number start with "0".

3

## ACCESS SHOWVIEW PROGRAM SCREEN

Press **OK**, and the ShowView Program screen appears (if you're just starting out, "P1" appears).

The display panel shows the programme start time. Pressing **PROG. CHECK** changes the display to the programme stop time, then the date and channel position.

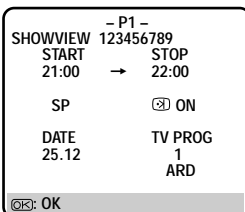

### IMPORTANT

Be sure to confirm the setting of PDC/VPS recording.

- If "ON" is displayed on the screen or "ON" is lit on the display panel, PDC/VPS is set to ON.
- If "OFF" is displayed on the screen or "OFF" is not lit on the display panel, PDC/VPS is set to OFF. To change the setting, press **OK** : PDC/VPS (NUMBER key "7").

☞ "PDC/VPS Recording" on page 33.

- Make sure the channel position number you wish to record is displayed; if not, see "ShowView Setup" on page 10 and set the Guide Program number for that ShowView number correctly.
- If the number you entered is invalid, "ERROR" appears on the screen and "Err" appears on the display panel. Press **CANCEL** to backspace and input a valid ShowView number.
- If "ERROR=GUIDE PROG" appears on the screen, see "ATTENTION – Regarding Guide Program Number Set" in the right column.
- If you are using the Illumi-Guide feature, **OK** blinks.

## SET TAPE SPEED

Press **SP/LP** (///) to set the tape speed.

4

## RETURN TO NORMAL SCREEN

Press **OK**.

- Repeat steps 1 – 5 for each additional programme.

5

## ENGAGE RECORDER'S TIMER MODE

Press **TIMER**. The recorder turns off automatically.

6

## NOTE:

*To Delay The Stop Time . . .*

. . . press **ADD TIME** (NUMBER Key "5") after pressing **OK** in step 3. Each time you press, the Stop time is delayed by 5 minutes (meaning that 5 minutes of recording time is added). You can easily compensate for anticipated programme schedule delays this way.

*To Timer-Record Weekly Or Daily Serials . . .*

. . . after pressing **OK** in step 3, press **WEEKLY** (NUMBER key "9") for weekly serials or **DAILY** (NUMBER key "8") for daily serials (Monday–Friday). Either "WEEKLY" or "DAILY" appears on the screen. Pressing the button again makes the corresponding indication disappear.

You can programme this recorder to timer-record as many as 8 programmes. If you try to programme the recorder to record a ninth, "PROGRAM FULL" appears on screen and "FULL" appears on the front display panel. To record the extra programme, you must first cancel any unnecessary programmes (☞ pg. 32).

### Satellite Tuner Users

To timer-record a satellite broadcast using ShowView, perform steps 1 – 6 and, before the selected programme begins, select the appropriate channel on the satellite tuner. Then set the tuner's timer. If your satellite tuner doesn't have a timer, leave the unit's power switched on.

## ATTENTION

### Regarding Guide Program Number Set

"ERROR=GUIDE PROG" appears after performing step 3 on the previous page if the Guide Program number for the ShowView number you entered has not been set.

- If the recorder is in the stop or rewind or fast-forward mode, the following screen will appear with "--" under "TV PROG" blinking.
- Press the **NUMBER** keys or **PUSH JOG**  $\Delta \nabla$  to input the channel position number you recorder receives that station on, then press **OK**.

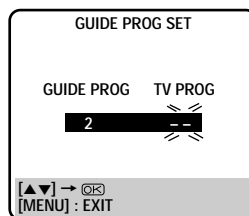

(Ex.) To timer-record a ZDF programme with ShowView \* If your recorder receives ZDF on the channel position 2, press **OK** after entering "2".

- Press **MENU**, then try again from step 1.
- If the recorder is in a mode other than the above mentioned modes, press **MENU** first and input the correct Guide Program number for that ShowView number (☞ pg. 10, "ShowView Setup"), then try again from step 1.

# Regular Timer Programming

Remember, the clock must be set before you can programme the timer (see pg. 49).

Before performing the following steps:

- Insert a cassette with the safety tab in place. The recorder will come on automatically.
- Turn on the TV and select the VIDEO channel (or AV mode).

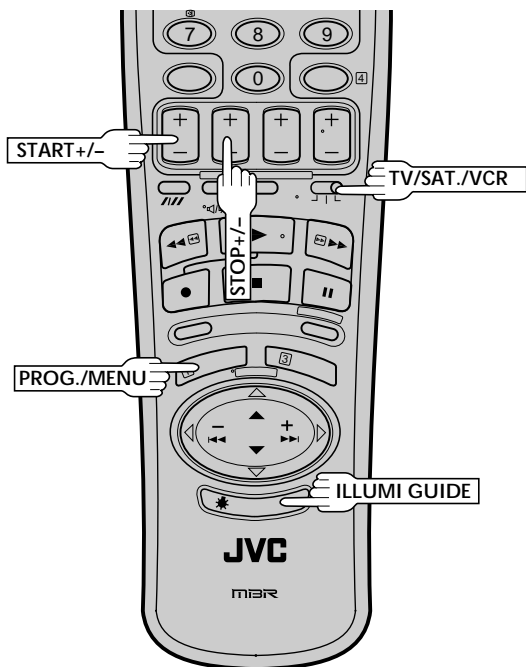
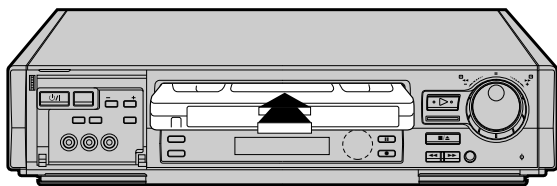

## When Using The Illumi-Guide Feature

- Buttons light or blink on the remote control for approximately 10 seconds. If the button or buttons extinguish during timer programming, press **ILLUMI GUIDE** and the button or buttons previously lit or blinking come back on. If the button or buttons do not re-light or start blinking again, press **MENU** and re-perform the timer programming procedure from the beginning.
- If for some reason the remote control's signal is not received by the video recorder, press **MENU** and re-perform the timer programming procedure from the beginning.

If you don't know the SHOWVIEW number for the programme you wish to record, use the following procedure to set your recorder to timer-record the programme. Or you can use the Illumi-Guide feature, where the remote control tells you which button to press next by lighting it up. To use the Illumi-Guide feature, with the **TV/SAT./VCR** switch set to "VCR", press **ILLUMI GUIDE** before performing step 1. (**PROG.**, **REW**, **PLAY**, **FF** light up at this time.)

If you aren't going to use the Illumi-Guide feature, go directly to step 1.

## ACCESS TIMER PROGRAMMING SCREEN

Press **PROG.**

- If you are using the Illumi-Guide feature, the following buttons will light up: **NUMBER** keys (0-9), **START +/-**, **STOP +/-**, **DATE +/-**, **TV PROG. +/-**, **MENU** and **CANCEL**.

## ACCESS PROGRAMME SCREEN

Press **START +/-**. (If you're just starting out, "P1" appears.)

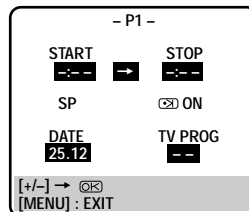

The front display panel looks like this:



- If you are using the Illumi-Guide feature, the following buttons will light up: **START +/-**, **STOP +/-**, **DATE +/-**, **TV PROG. +/-** and **MENU**.

## ENTER PROGRAMME START TIME

Press **START +/-** to enter the time you want recording to start.

- Press and hold **START +/-** to move in 30-minute increments, or press and release repeatedly to move 1 minute at a time.

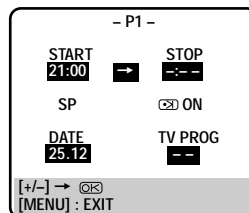

The front display panel looks like this:



- If you are using the Illumi-Guide feature, the following buttons remain lit: **START +/-**, **STOP +/-**, **DATE +/-**, **TV PROG. +/-** and **MENU**.

## ENTER PROGRAMME STOP TIME

Press **STOP +/-** to enter the time you want recording to stop.

- If you are using the Illumi-Guide feature, the following buttons remain lit: **START +/-**, **STOP +/-**, **DATE +/-**, **TV PROG. +/-** and **MENU**.

4

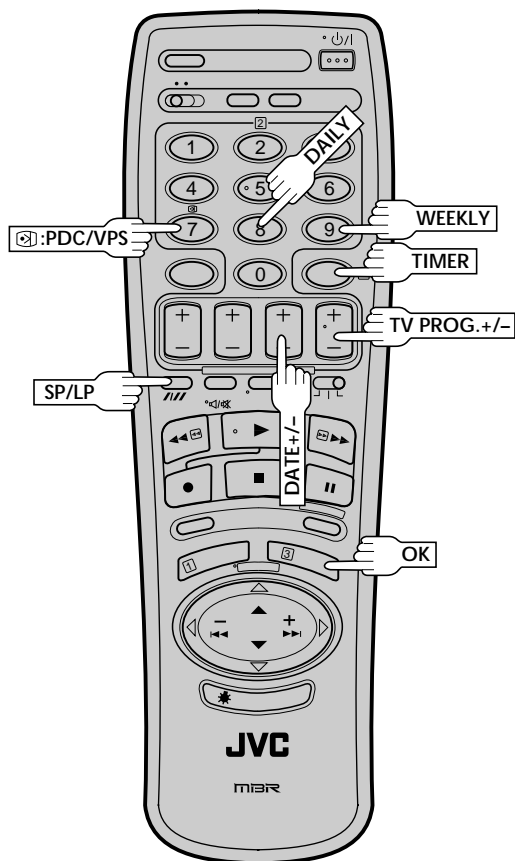
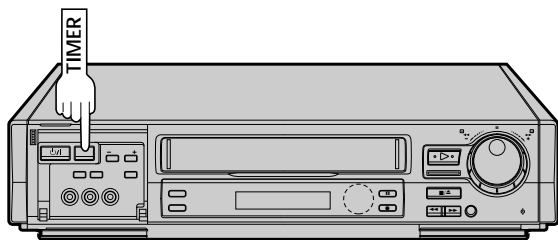

5

### ENTER PROGRAMME DATE

Press **DATE +/-**. (The current date appears on screen. The date you enter appears in its place.)

- If you are using the Illumi-Guide feature, the following buttons remain lit: **START +/-**, **STOP +/-**, **DATE +/-**, **TV PROG. +/-** and **MENU**.

6

### ENTER CHANNEL POSITION

Press **TV PROG. +/-**.

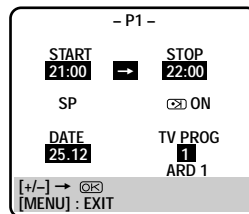

#### IMPORTANT

- Be sure to confirm the setting of PDC/VPS recording.
- If "ON" is displayed on the screen or "ON" is lit on the display panel, PDC/VPS is set to ON.
  - If "OFF" is displayed on the screen or "OFF" is not lit on the display panel, PDC/VPS is set to OFF. To change the setting, press **ON : PDC/VPS (NUMBER key "7")**.
- ☞ "PDC/VPS Recording" on page 33.

- If you are using the Illumi-Guide feature, **OK** blinks when the following buttons are lit: **START +/-**, **STOP +/-**, **DATE +/-**, **TV PROG. +/-** and **MENU**.

7

### SET TAPE SPEED

Press **SP/LP ( // )** to set the tape speed.

8

### RETURN TO NORMAL SCREEN

After confirming all information is correct, press **OK** and the normal screen appears.

- Repeat steps 1-8 for each additional programme.

9

### ENGAGE RECORDER'S TIMER MODE

Press **TIMER**. The recorder turns off automatically.

### NOTES:

- To timer-record a satellite broadcast through a satellite tuner connected to the AV2 IN/DECODER connector on the back of the recorder, in step 6 above, set "TV PROG" to "AUX2" by pressing **TV PROG. +/-**. Before the selected programme begins, select the appropriate channel on the satellite tuner, then set the tuner's timer. If your satellite tuner doesn't have a timer, leave the unit's power switched on.
- You can programme this recorder to timer-record as many as 8 programmes. If you try to programme the recorder to record a ninth, "PROGRAM FULL" appears on screen and "FULL" appears on the front display panel. To record the extra programme, you must first cancel any unnecessary programmes (☞ pg. 32).

To Timer-Record Weekly Or Daily Serials . . .

. . . anytime during steps 2 through 8, press **WEEKLY (NUMBER key "9")** for weekly serials or **DAILY (NUMBER key "8")** for daily serials (Monday-Friday). Either "WEEKLY" or "DAILY" appears on the screen. Pressing the button again makes the corresponding indication disappear.

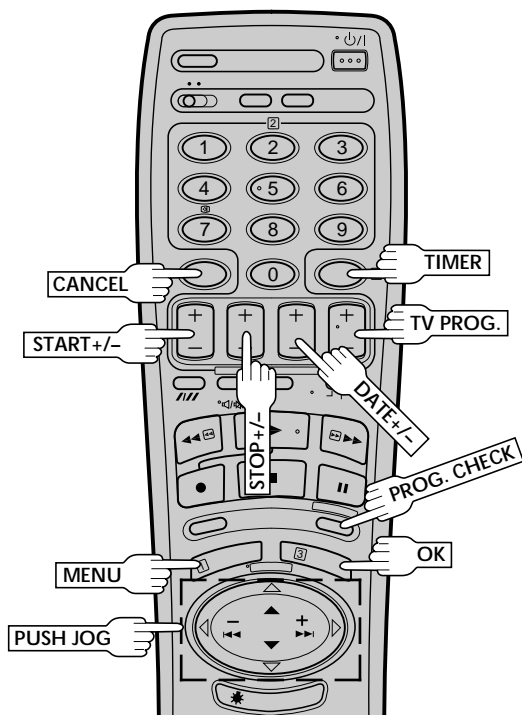

## Check And Cancel Programmes

### 1 ACCESS PROGRAMME DISPLAY AND/OR SCREEN

Press **PROG. CHECK**.

- The display panel shows the programme start time. Pressing **OK** changes the display to the programme stop time, then the date and channel position.
- If the recorder is turned on and the TV is set to its VIDEO channel or AV mode, you can check program information on screen as well.
- Each time you press **PROG. CHECK**, the next programme's information appears.

*If All Information Is Correct . . .*

. . . programming is completed.

*If You Wish To Revise Data . . .*

. . . with the recorder's power turned on, go to step 2.

*If You Wish To Cancel A Program . . .*

. . . with the recorder's power turned on, press **CANCEL**. All information you input is deleted.

### 2 REVISE PROGRAMME INFORMATION

Input the appropriate data using the **START +/-**, **STOP +/-**, **DATE +/-** and **TV PROG. +/-** buttons on the remote control.

## Auto Timer

When the Auto Timer is set to ON the timer is automatically engaged when the recorder power is turned off and automatically disengaged when the recorder is powered back on.

### 1 ACCESS MAIN MENU SCREEN

Press **MENU** twice.

### 2 ACCESS MODE SET SCREEN

Press **PUSH JOG**  $\Delta \nabla$  to move the highlight bar (pointer) to "MODE SET", then press **OK**.

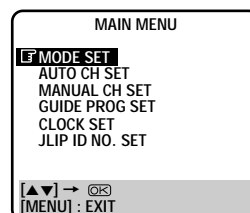

### 3 SELECT MODE

Press **PUSH JOG**  $\triangleright$  to select either "ON" or "OFF".

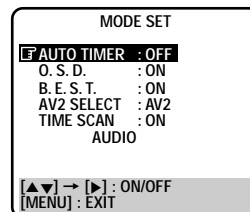

### 4 RETURN TO NORMAL SCREEN

Press **MENU**.

## NOTE:

*For safety, when Auto timer is set to "OFF", all other recorder functions are disabled while the Timer mode is engaged. To disengage the timer, press **TIMER**.*



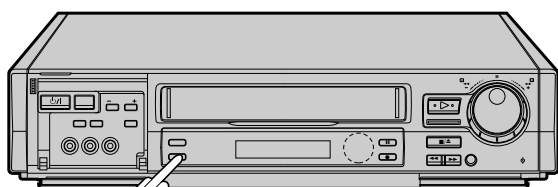

AUTO SP/LP TIMER

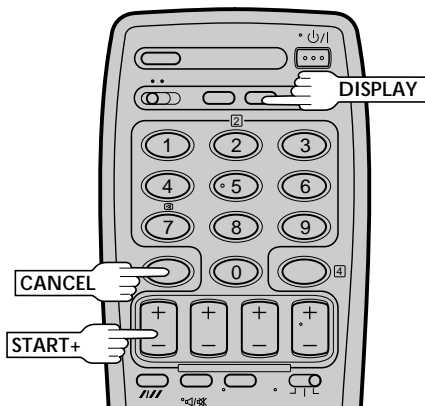

## Auto SP/LP Timer

If, when recording in SP mode, there is not enough tape to record the entire programme, the recorder automatically switches to LP mode to allow complete recording.

### ENGAGE AUTO SP/LP TIMER

1

Press **AUTO SP/LP TIMER** on the recorder front panel. The button lights up.

**For Example . . .**

Recording a program of 210 minutes in length onto a 180-minute tape

Approximately 150 minutes

Approximately 60 minutes

SP mode	LP mode
Total 210 minutes	

Make sure you press **AUTO SP/LP TIMER** before performing timer programming.

### NOTES:

- The Auto SP/LP Timer feature is not available during ITR (Instant Timer Recording), and the feature will not work properly with any tapes longer than E-180 as well as some tapes of shorter lengths.
- Even if, in step 1, you press **AUTO SP/LP TIMER** and the button lights up, that doesn't mean that the recorder will automatically change from SP to LP mode during the course of the recording. Watch the tape later to confirm.
- If you have programmed the recorder to timer-record 2 or more programmes, the second programme and those thereafter may not fit on the tape if you engage the Auto SP/LP Timer mode. In this case, make sure the mode is not engaged, then set the tape speed manually during timer programming.
- There may be some noise at the point on the tape where the recorder switches from SP to LP mode.
- If you perform timer recording with both PDC/VPS and the Auto SP/LP Timer activated, and the programme goes beyond its originally scheduled length, there may be times when the programme cannot be recorded in its entirety.

## PDC/VPS Recording

Now available from some TV stations, PDC (Programme Delivery Control) and VPS (Video Programme System) are services designed to assure safe, accurate timer recording. With this system, special code signals are transmitted together with the audio/video signals. These code signals control your video recorder and have precedence over advertised times you preset in the timer. This means that your recorder will start and stop recording when the preset TV programmes actually start and end — even if the broadcast time of a preset TV programme is changed.

### NOTES:

- When you manually enter programmes (regular timer programming), set the start time (PDC or VPS time) exactly as advertised in the TV listing. A different time than advertised will result in no recording.
- PDC/VPS recording is not possible in areas where no TV station transmits PDC or VPS signals.
- PDC/VPS recording is also possible when a satellite tuner or a cable system is connected to the AV2 IN/DECODER connector on your recorder.
- PDC/VPS recording is also possible via the AV1 IN/OUT connector and the front panel connectors.

### How to check if the station being received transmits a PDC/VPS signal

- 1 Press **DISPLAY** until the channel position appears on the display panel.
- 2 Hold down **START +** for about 5 seconds.
  - "ⓧ" appears blinking on the display panel.
  - If a PDC/VPS signal is detected from the station, "ⓧ" will stop blinking.
  - If no PDC/VPS signal is detected from the station, "ⓧ" will blink at a slower rate.
- 3 Press **DISPLAY** or **START +** again to return to normal display.

## Timer Warning

If you have programmed your recorder to timer-record a programme or a series of programmes, a warning appears on screen to tell you that the recording is to start in 5 minutes.

— WARNING —  
TIMER RECORDING  
TO START SOON  
[CANCEL]

### NOTES:

- The warning only appears if you're not in the Timer mode at that time.
- If this recorder is being used as the player for tape dubbing, the warning screen is recorded on the tape in the other video recorder.

The warning blinks for the entire 5 minutes leading up to the start of timer recording. To clear the display, press **CANCEL**.

# Edit To Or From Another Video Recorder

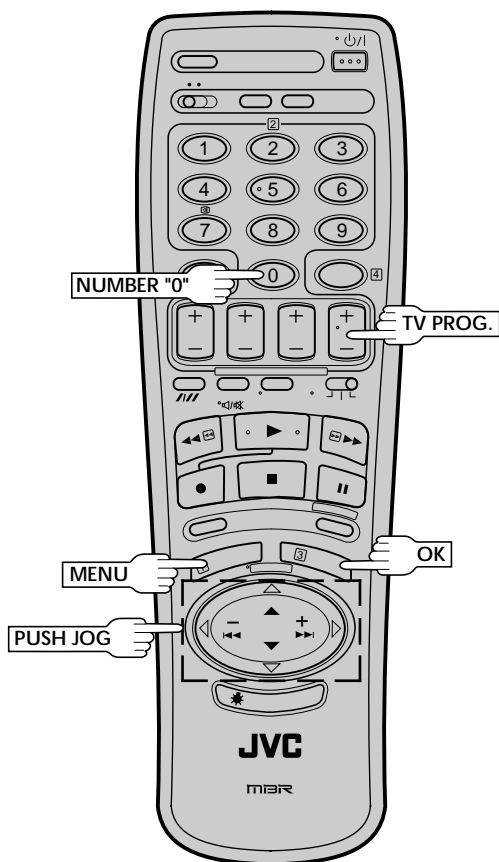

You can use your video recorder as the source player or the recording deck.

## 1 MAKE CONNECTIONS

Connect the player's 21-pin SCART (AV) connector to the recorder's 21-pin SCART (AV) connector as illustrated on page 35.

*When Using Your Video Recorder As The Source Player . . .*

. . . connect its AV1 IN/OUT connector to the recording deck.

*When Using Your Video Recorder As The Recording Deck . . .*

. . . connect its AV2 IN/DECODER or AV1 IN/OUT connector to the source player.

## 2 SET RECORDING DECK'S INPUT MODE

Set to AUX. With this video recorder, press **NUMBER** key "0" and/or **TV PROG.** to select depending on the connector being used — "AU-1" for the AV1 IN/OUT connector, or "AU-2" for the AV2 IN/DECODER connector.

- When using the AV2 IN/DECODER connector, make sure "AV2 SELECT" is set to "AV2" (see below).

## 3 START SOURCE PLAYER

Engage its Play mode.

## 4 START RECORDING DECK

Engage its Record mode.

### NOTES:

- All necessary cables can be obtained from your dealer.
- If you use this recorder as the player for editing, be sure to turn off 3R Picture before starting. (☞ pg. 14)

## AV2 SELECT Setting

- 1 Press **MENU** twice to access the Main Menu screen.
- 2 Press **PUSH JOG**  $\Delta$ / $\nabla$  to move the highlight bar (pointer) to "MODE SET", then press **OK**.
- 3 Press **PUSH JOG**  $\Delta$ / $\nabla$  to move the highlight bar (pointer) to "AV2 SELECT".
- 4 Press **PUSH JOG**  $\triangleright$  to move the highlight bar (pointer) to your choice:
  - a-AV2 : To use this recorder as the recording deck with the player connected to the AV2 IN/DECODER connector.
  - b-DECODER : To use a decoder connected to the AV2 IN/DECODER connector.
- 5 Press **MENU** to return to normal screen.

- If you have a decoder, be sure to set "AV2 SELECT" back to "DECODER" after editing.
- If you're not using a decoder, leave "AV2 SELECT" set to "AV2".
- The default setting is "AV2"; if the recorder's memory backup has expired due to a power cut or because the AC was removed from the recorder, "AV2" will be automatically selected when the power is restored to the recorder. If you are using a decoder, be sure to set "AV2 SELECT" back to "DECODER".

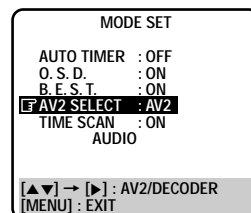

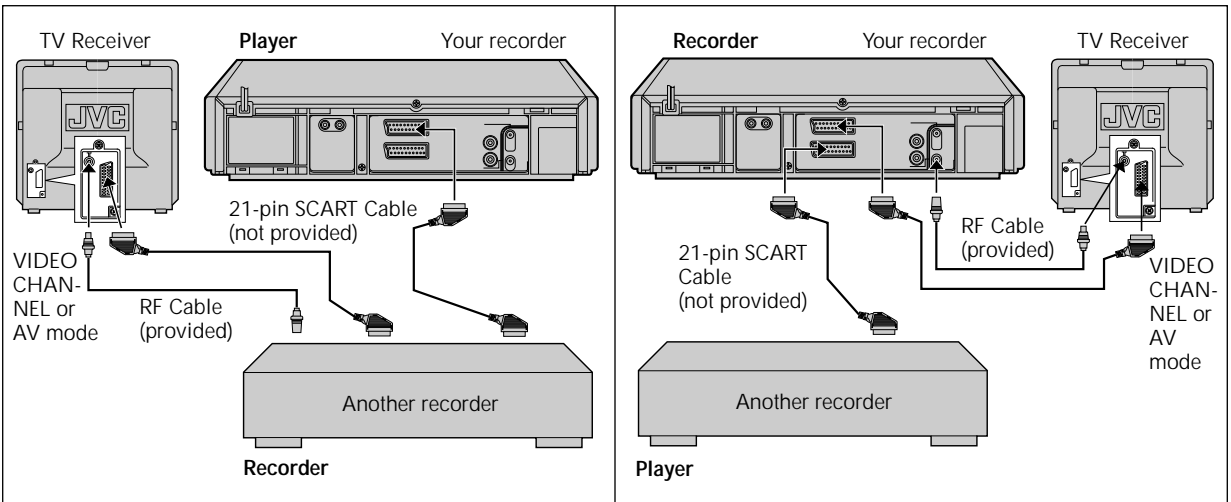

**For Customers in Australia and New Zealand:**

When connecting the AV cable, use the input and/or output cable adapter as illustrated below.

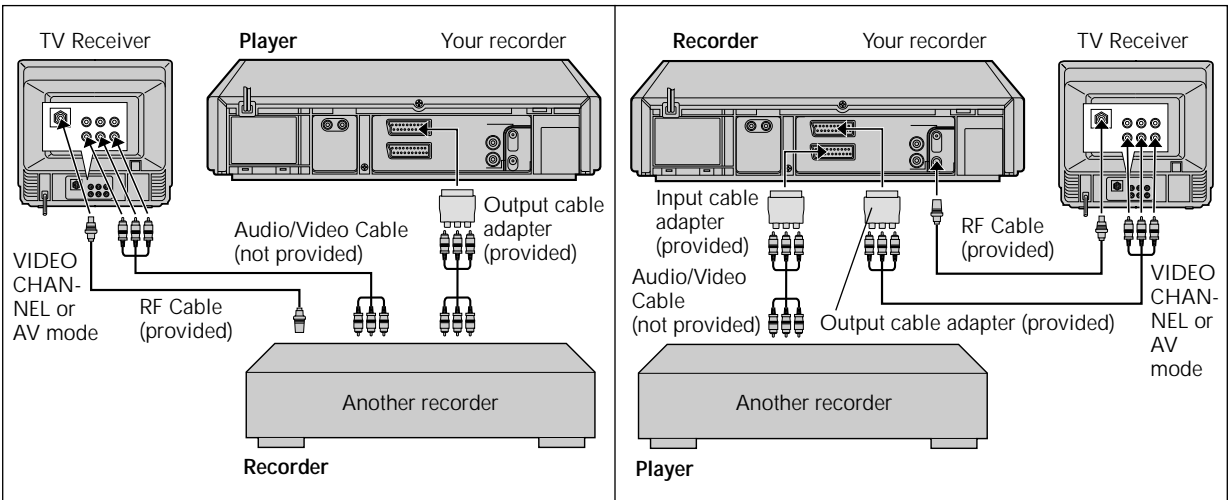

# Edit From A Camcorder

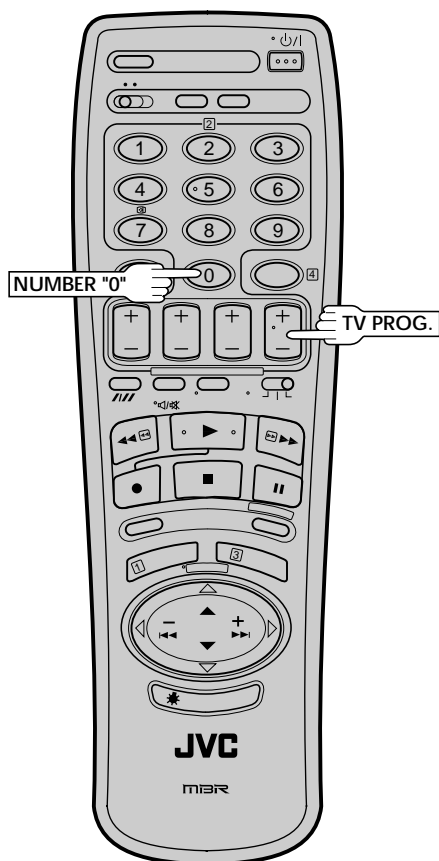

You can use a camcorder as the source player and your video recorder as the recorder.

1

## MAKE CONNECTIONS

Connect the camcorder's AUDIO/VIDEO OUT connectors to the recorder's front panel AUDIO/VIDEO input connectors.

- When using a monaural camcorder, connect its AUDIO OUT connector to the AUDIO IN L input connector on your recorder.
- When a Master Edit Control-equipped JVC camcorder is used, the camcorder is capable of controlling the recorder. Refer to the camcorder's instruction manual for operating procedure.

2

## SET RECORDER'S INPUT MODE

Press **NUMBER** key "0" and/or **TV PROG.** so that "F-AU" appears in place of a channel position number.

3

## START CAMCORDER

Engage its Play mode.

4

## START RECORDER

Engage its Record mode.

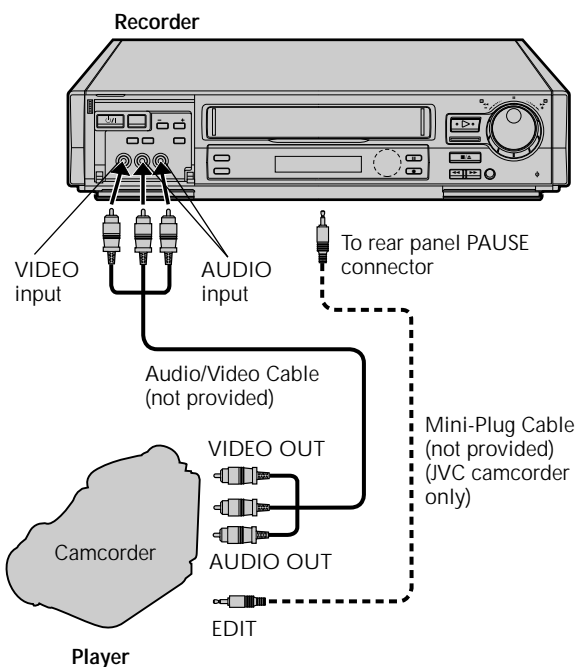

# Audio Dubbing

Audio dubbing replaces the normal audio sound of a previously recorded tape with a new soundtrack.

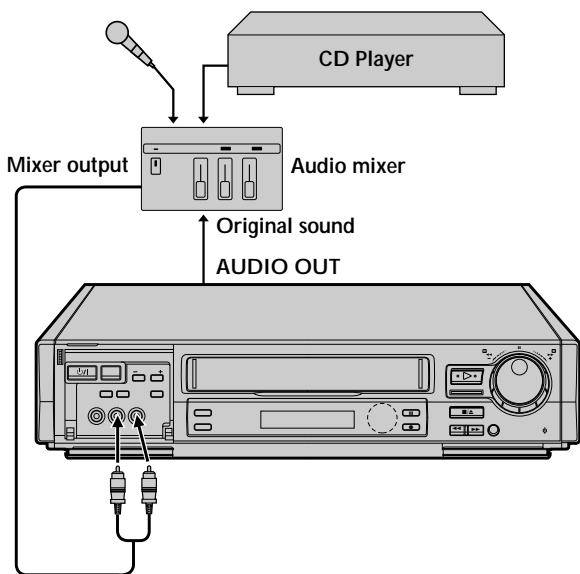
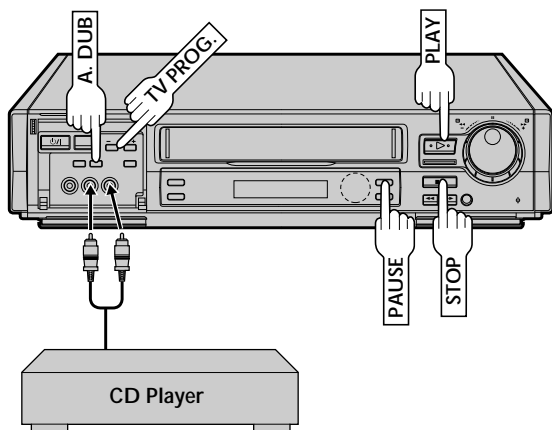
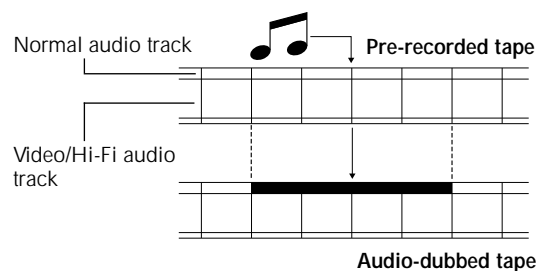

## NOTES:

- When monitoring the sound during Audio Dubbing, the normal soundtrack is automatically selected. If you wish to hear the mixed sound (Hi-Fi + Normal soundtracks), press **AUDIO MONITOR** on the remote control to select "L+R+NORM" (☞ pg. 16).
- Audio dubbing stops automatically when the counter reaches "0:00:00", and the recorder enters the Play mode. Check the counter reading before dubbing.
- Audio dubbing is also possible using the rear panel AV1 IN/OUT or AV2 IN connector. When using these connectors, make sure to select the correct input mode in step 2.
- Audio dubbing cannot be performed on a cassette that has had its record safety tab removed.
- When playing back an audio-dubbed tape, press **AUDIO MONITOR** on the remote control to select the soundtrack you wish to hear (☞ pg. 16).

## 1 MAKE CONNECTIONS

Connect an audio component to the AUDIO IN L + R connectors on the recorder's front panel.

- When connecting monaural equipment, use only the recorder's AUDIO IN L connector.

## 2 SET INPUT MODE

Press **NUMBER** key "0" and/or **TV PROG.** so that "F-AU" appears in place of a channel number.

## 3 LOCATE START POINT

Press **PLAY** to start playback of the tape in your recorder, and press **PAUSE** when you find the point where you want to start dubbing.

## 4 ENGAGE AUDIO DUBBING

Press **A. DUB**.

- Your recorder enters the Audio Dubbing Pause mode. ("O" blinks, "▷" and "□" light up on the front display panel.)
- To perform audio dubbing with audio mixing, press **AUDIO MONITOR** on the remote control to select "L + R" at this point. \*Audio dubbing with audio mixing is not possible if you're using a monaural audio component, or if you don't have an audio mixer.

## 5 START DUBBING

Engage the audio component's Play mode, then press **PLAY** to start the tape in your recorder. Audio dubbing begins at this point.

- "O" blinks and "▷" is displayed on the front display panel.
- To stop dubbing temporarily, press **PAUSE**. Press **PLAY** to resume dubbing.

## 6 END AUDIO DUBBING

Press **STOP** to stop the tape in your recorder, and engage the audio component's Stop mode.

# Insert Editing

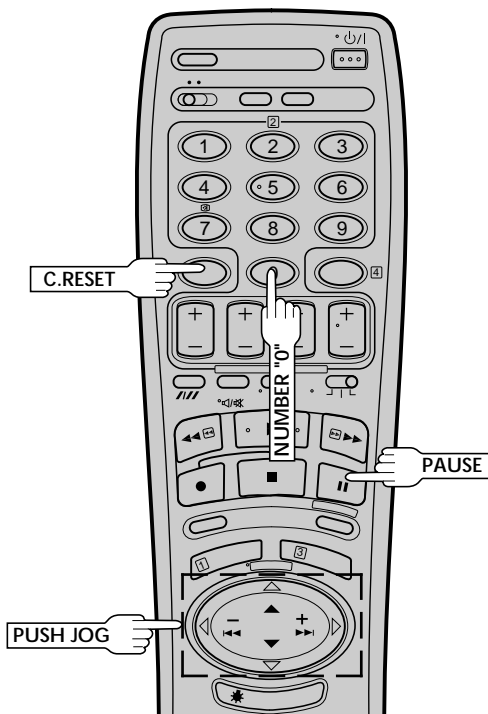
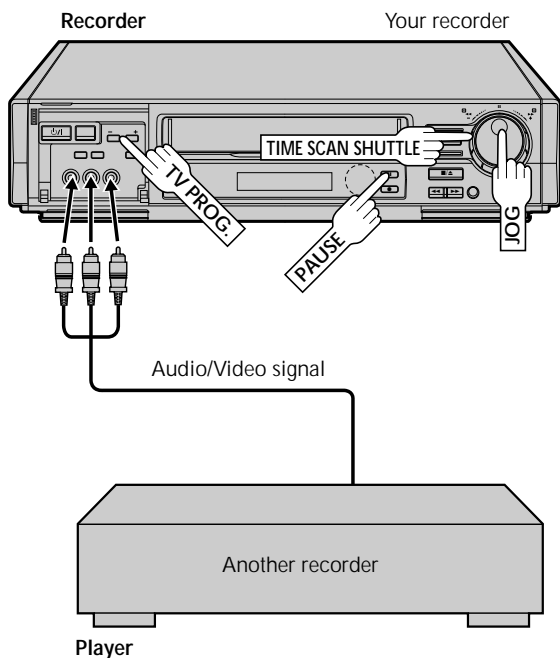

Insert editing replaces part of the recorded scene with new material. Both the picture and Hi-Fi audio soundtrack are replaced with new ones, while the normal audio soundtrack remains unchanged. If you wish to change the normal audio track as well, use the audio dubbing function simultaneously. Use your video recorder as the recorder.

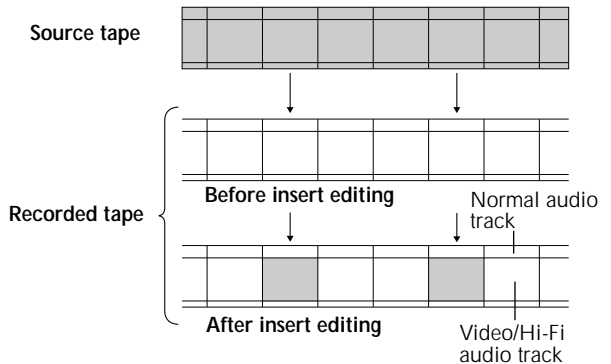

## 1 MAKE CONNECTIONS

Connect the player's VIDEO OUT and AUDIO OUT connectors to your recorder's VIDEO IN and AUDIO IN on the front panel.

## 2 SET INPUT MODE

Press **NUMBER** key "0" and/or **TV PROG.** so that "F-AU" appears in place of a channel number.

## 3 LOCATE END POINT

Load the recording cassette into your recorder, and play it back to determine the edit-out point (the end of the segment to be replaced) using the **JOG/TIME SCAN SHUTTLE** controls or **PUSH JOG** ◀▶ and **PAUSE**.

## 4 RESET THE COUNTER

Press **C.RESET** to change the counter display to "0:00:00".

## 5 LOCATE START POINT

Determine the edit-in point (the beginning of the segment to be replaced) using the **JOG/TIME SCAN SHUTTLE** controls or **PUSH JOG** ◀▶ and **PAUSE**.

- Be sure to engage the Still mode at the edit-in point.

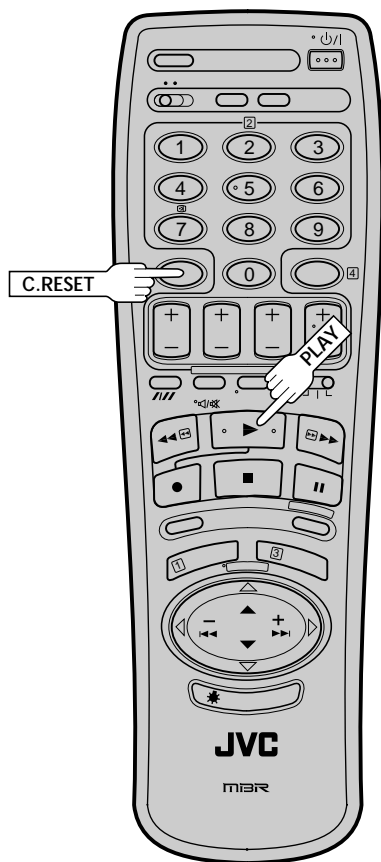
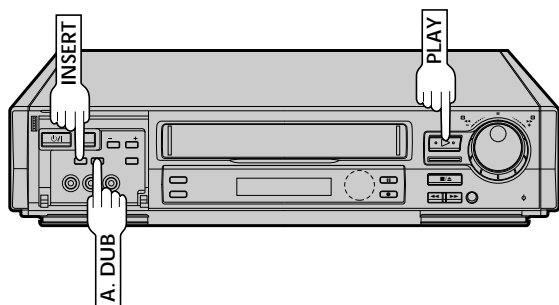

6

## ENGAGE INSERT EDITING

Press **INSERT**.

- Your recorder enters the Insert-Pause mode. ("O", "▷" and "□□" light up on the front display panel.)
- The TV screen changes from the still picture to the input source you are going to record.

7

## START EDITING

Load the source cassette and play back the segment that is to be inserted. When you reach the start of the section of the source tape that you wish to insert, press **PLAY** to start the tape in your recorder; Insert Editing begins at this point.

- "O" and "▷" are displayed on the front display panel.

8

## END INSERT EDITING

At counter "0:00:00", Insert Editing will stop automatically while the tape continues running in the Play mode. If you wish to stop Insert Editing before the specified edit-out point, press **C.RESET**.

### FOR AV INSERT EDITING

If you want to replace the picture, Hi-Fi audio soundtrack and normal audio soundtrack all at the same time...

In step 6 above, after you press **INSERT**, press **A. DUB** also. ("O" and "▷" blink and "□□" lights up on the front display panel.)

### NOTES:

- Suitable leads can be obtained from your dealer.
- Insert editing is not possible with cassettes whose safety tab has been removed.
- When insert editing is performed on a tape that has been recorded on another video recorder, the inserted portion may appear distorted.
- In insert editing, the recording speed (SP/LP) is determined by the previous recording to be replaced. If the previous recording's speed changes within a single edit, the inserted picture will be distorted at the switching point.
- A small portion of the recording which precedes an insert edit may become erased.
- Insert Editing is also possible using the rear panel AV1 IN/OUT or AV2 IN connector. When using these connectors, make sure to select the correct input mode in step 2.

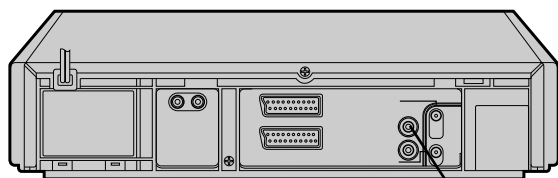

J terminal

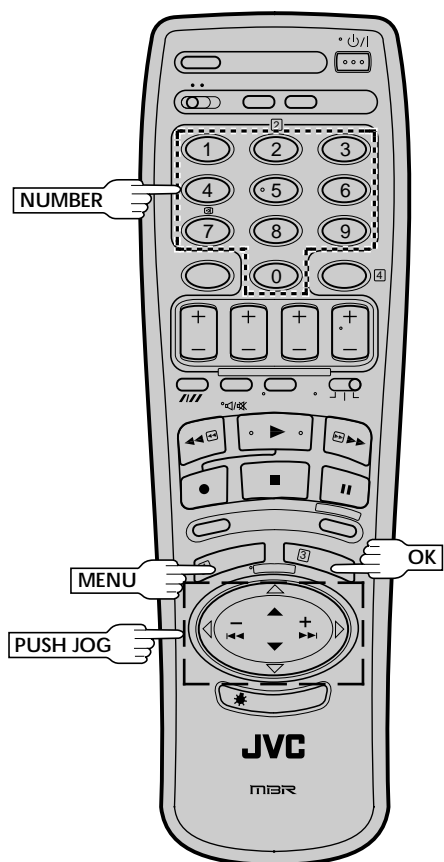

## ATTENTION

After you change your recorder's JLIP ID number, control signal transmission may not work properly. If this happens, turn off the recorder's power off once, then turn it back on and try again.

## J Terminal (JLIP(Joint Level Interface Protocol) Connector)

The J Terminal is used to connect the recorder to a personal computer or similar device to allow computerized control of the recorder during editing and certain other operations.

### Examples:

- Enables Random Assemble Editing of up to 99 segments with the optional JLIP PLAYER PACK HS-V1EG, using this recorder as the playback unit. (Use this recorder's PAUSE connector in lieu of the EDIT jack.)
- Allows you to capture still images from the recorder into a personal computer with the optional JLIP VIDEO CAPTURE BOX GV-CB1E.

For further details consult your nearest JVC dealer. Information (in English) is also available at one of JVC's World Wide Web sites at <http://www.jvc-victor.co.jp/>

### JLIP ID Number

Your recorder has its own JLIP ID number. This ID number must be unique when your recorder is connected to another device via its J terminal. The ID Number is preset to "1" at the factory. You can change this number to any number between "1" and "99". If it is necessary to change the JLIP ID number perform the following steps.

## 1 ACCESS MAIN MENU SCREEN

Press **MENU** twice.

## 2 ACCESS JLIP ID NO. SET SCREEN

Press **PUSH JOG**  $\Delta \nabla$  and move the highlight bar (pointer) to "JLIP ID NO. SET", then press **OK**.

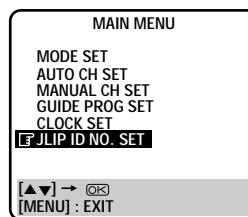

## 3 SET JLIP ID NUMBER

Press **PUSH JOG**  $\Delta \nabla$  to enter the desired ID number.

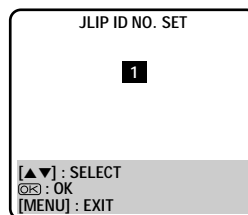

## 4 RETURN TO NORMAL SCREEN

Press **MENU** or **OK**.



# Connecting/ Using A Decoder

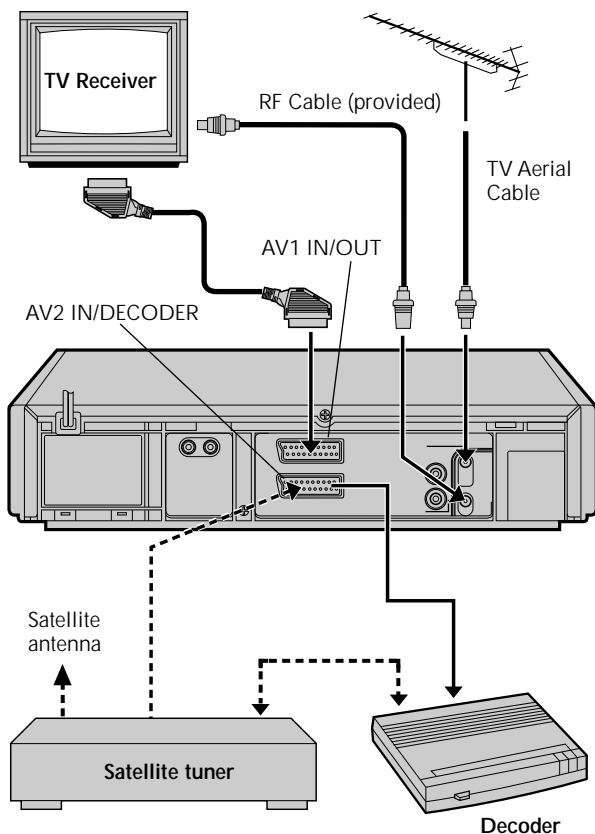

#### For Customers in Australia and New Zealand:

When connecting the AV cable, use the input and/or output cable adapter.

The AV2 IN/DECODER connector can be used as an input terminal for an external decoder (descrambler). Simply connect a decoder and you can enjoy the variety of programming that is available through scrambled channels.

## 1 SELECT INPUT MODE

Set "AV2 SELECT" to "DECODER". (☞ pg. 34)

## 2 CONNECT DECODER

Connect your recorder's AV2 IN/DECODER connector to the decoder's Euroconnector using a 21-pin SCART cable.

## 3 SET TUNER

Perform the procedure as described in "When Receiving A Scrambled Broadcast" on page 46.

### NOTE:

#### When Connecting A Satellite Tuner . . .

. . . if you don't have a decoder connect the satellite tuner directly to the video recorder's AV2 IN/DECODER connector.  
 . . . if you have a decoder, first connect the decoder to the decoder input of the satellite tuner, then connect the satellite tuner's output to the recorder's AV2 IN/DECODER connector. Refer to the instruction book for the satellite tuner and decoder.  
 . . . set "AV2 SELECT" to "AV2". (☞ pg. 34)  
 . . . to view a programme via the satellite tuner, select AU 2 mode by pressing **NUMBER** keys and/or **TV PROG.** so that "AU-2" appears on the display panel.

# TV Multi-Brand Remote Control

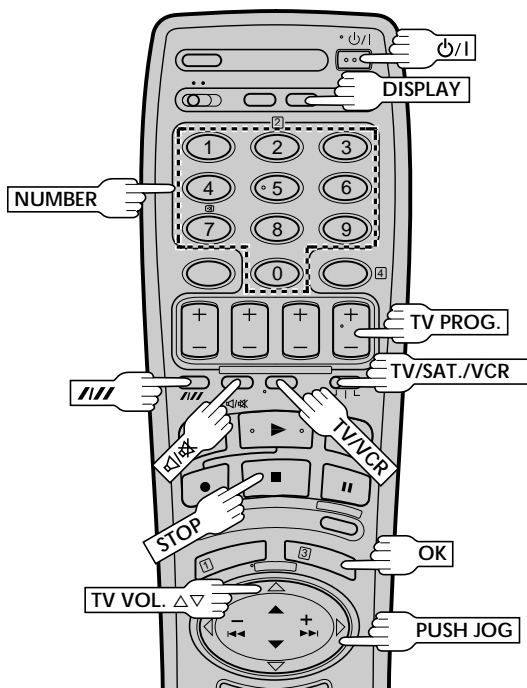

## Control Your TV Using Additional Buttons

The **NUMBER** keys on the remote can also be used to select the TV's channel by setting the remote control to the TV mode.

- 1 Set the **TV/SAT./VCR** switch to TV.
  - 2 Use the **NUMBER** keys, and the **///** (Digit Entry) button, the **PUSH JOG** button, the **DISPLAY** button or the **OK** button to select the TV's channel.
- With televisions under Code 01, 02, 03, 04, 06, 07, 09, 10, 13, 14 or 22, the **///** button corresponds to the 1-digit/2-digit entry switching button (often labelled - / -) of your TV's remote control.
  - With televisions under Code 01, 11 or 12, the **PUSH JOG** < button corresponds to the 10 + button, and the **PUSH JOG** > button corresponds to the 20 + button of your TV's remote control.
  - With televisions using Code 12, the **DISPLAY** button corresponds to the 30 + button.
  - With televisions using Code 09, the **OK** button corresponds to the ENTER button of your TV's remote control.

### NOTE:

The way these buttons are used is determined by your TV. Use these buttons as instructed for your TV's remote control.

Your remote control can operate the basic functions of your TV set. In addition to JVC TVs, other manufacturer's TVs can also be controlled by setting the appropriate switch on the remote control.

Before you start . . .

- Turn on the TV using its remote control.
- Set the remote control's **TV/SAT./VCR** switch to TV.

## 1 SET TV BRAND CODE

Refer to the chart below. While holding down **⏻**, enter your TV's brand code using the **NUMBER** keys, then press **STOP**.

- JVC has four codes. If the TV does not function with one code, try entering another.
- You don't have to repeat this step until you replace your remote control's batteries.

## 2 TRY OPERATING TV

Press **⏻** on the remote to turn the TV off. If it goes off, try other operations.

- The **⏻** button, **TV/VCR** button, **TV PROG.** +/- button, **TV VOL.** Δ▽ button and **⏻** (Mute) button on the remote can all be used to operate the TV.
- To return the remote to video recorder control, set its **TV/SAT./VCR** switch to VCR.

## IMPORTANT

Although the provided remote control unit is compatible with JVC televisions, as well as many other models, it may not work with your TV, or in some instances, may have limited function capability.

TV BRAND NAME	CODE
JVC	01, 02, 03, 04
BRANDT	05
NORDMENDE	05
SABA	05
TELEAVIA	05
TELEFUNKEN	05
THOMSON	05
FERGUSON	06
PHILIPS	07
BLAUPUNKT	08
GRUNDIG	08
SONY	09
PANASONIC	10
GRAETZ	11
ITT	11
LUXOR	11
SALORA	11
SELECO	11
MIVAR	12
HITACHI	13
TOSHIBA	14
MITSUBISHI	15
FINLUX	16
NOKIA	17
SHARP	18
FUNAI	20
NEC	22

# Satellite Tuner Multi- Brand Remote Control

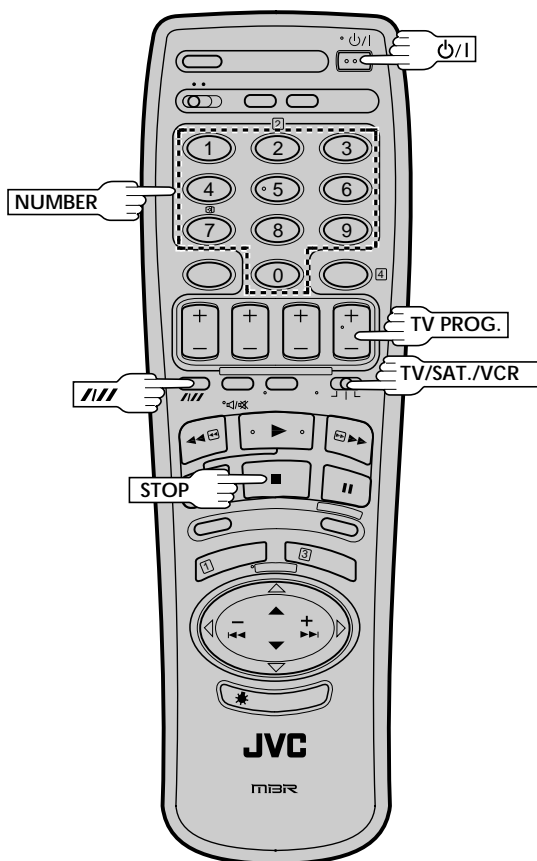

Your remote control can operate the basic functions of your satellite tuner set. In addition to JVC satellite tuners, other manufacturer's satellite tuners can also be controlled by setting the appropriate switch on the remote control.

Before you start . . .

- Turn on the satellite tuner using its remote control.
- Set the remote control's **TV/SAT./VCR** switch to **SAT**.

## 1 SET SATELLITE TUNER BRAND CODE

Refer to the chart below. While holding down  $\text{P}/\text{I}$ , enter your satellite tuner's brand code using the **NUMBER** keys, then press **STOP**.

- Some satellite tuner brands have more than one code. If the satellite tuner does not function with one code, try entering another.
- You don't have to repeat this step until you replace your remote control's batteries.

## 2 TRY OPERATING SATELLITE TUNER

Press  $\text{P}/\text{I}$  on the remote to turn the satellite tuner off. If it goes off, try other operations.

- The  $\text{P}/\text{I}$  button, **TV PROG.** +/- button, **NUMBER** buttons on the remote can all be used to operate the satellite tuner.
- The **NUMBER** buttons will not work with JVC satellite tuners using code 13.
- With satellite tuners using Code 16, the **///** button corresponds to the ENTER button of your satellite tuner's remote control.
- To return the remote to video recorder control, set its **TV/SAT./VCR** switch to **VCR**.

## IMPORTANT

*Although the provided remote control unit is compatible with JVC satellite tuners, as well as many other models, it may not work with your satellite tuner, or in some instances, may have limited function capability.*

SATELLITE TUNER BRAND	CODE
JVC	13, 14
AMSTRAD	01, 02, 03, 04
SIEMENS	05
GRUNDIG	05, 06
KATHREIN	05, 11, 12
PACE	06, 08
PHILIPS	07
ITT	09
NOKIA	09
SKYMASTER	10
RFT	10
MASPRO	11
BT	13
PANASONIC	15
JERROLD	16

Turn on the TV and select the VIDEO channel (or AV mode).

### IMPORTANT

Perform the following steps only if auto channel set has not been set correctly by Auto Set Up function (pg. 4) or if you have moved to a different area or if a new station starts broadcasting in your area.

Your recorder needs to memorise all necessary stations in channel positions in order to record TV programmes. Auto Channel Set automatically assigns all receivable stations in your area so that you can call them up with the **TV PROG.** buttons without going through any vacant channels.

## Auto Channel Set

### 1 TURN ON THE RECORDER

Press **ON/1**.

### 2 ACCESS MAIN MENU SCREEN

Press **MENU** twice.

### 3 ACCESS COUNTRY SET SCREEN

Press **PUSH JOG**  $\Delta$   $\nabla$  to move the highlight bar (pointer) to "AUTO CH SET", then press **OK**.

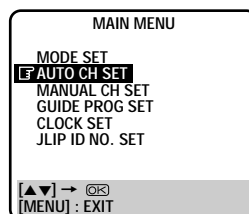

### 4 SELECT COUNTRY

Press **PUSH JOG**  $\Delta$   $\nabla$  to move the highlight bar (pointer) to your country's name, then press **OK**. The Language Set screen appears.

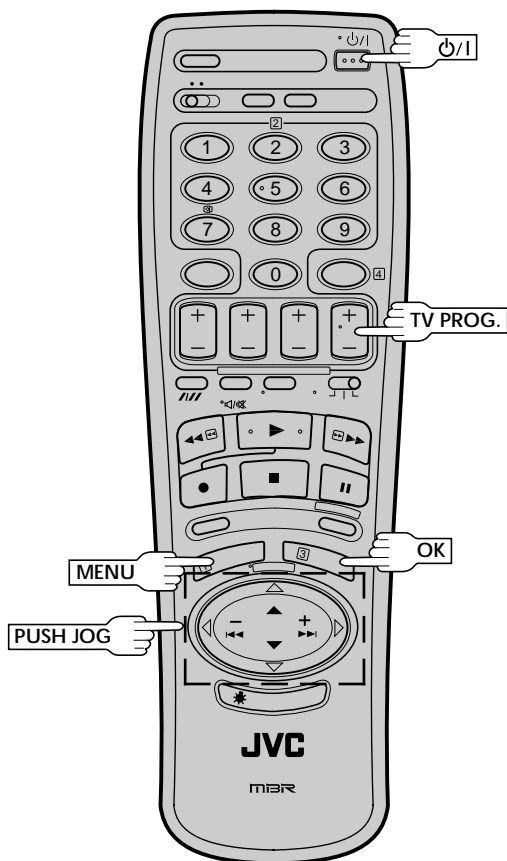

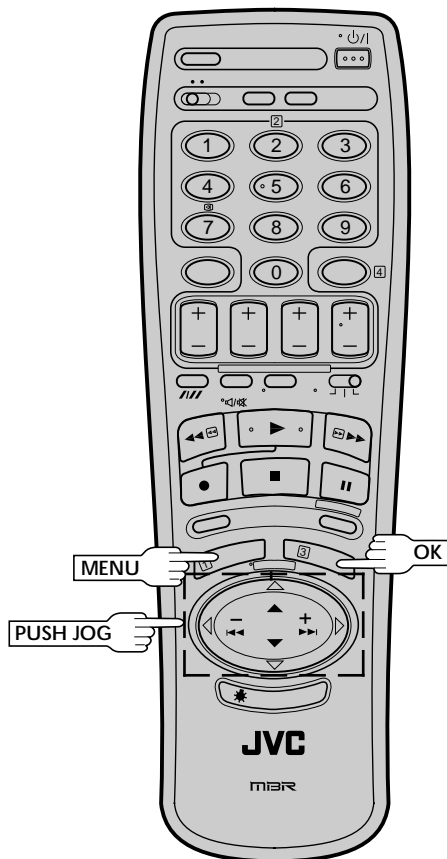

## IMPORTANT

- Depending on the reception conditions, the station names may not be stored correctly, and auto Guide Program Number Set may not work properly. If the Guide Program numbers are not set properly, SHOWVIEW timer recording (pg. 28) will not work correctly; be sure to check if the Guide Program numbers have been set correctly (pg. 10, "SHOWVIEW Setup").
- Since your video recorder memorizes all detected stations even if the reception condition is poor, some of those stored stations may produce a noisy picture. To delete those stations, use "Delete A Channel" on page 46.

## PERFORM AUTO CHANNEL SET

5

Press **PUSH JOG**  $\Delta \nabla$  to move the highlight bar (pointer) to the language of your choice, then press **OK** to initiate Auto Channel Set.

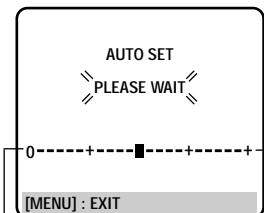

- The Auto Set screen appears, and remains on screen while the recorder searches for receivable stations. As Auto Channel Set progresses, the "■" mark on the screen moves from left to right. Wait until the screen as shown in step 6 appears.

## VIEW CONFIRMATION SCREEN

6

The stations your recorder located appear on a Confirmation screen — channel positions (PR), channels (CH) and station names (ID— pg. 48). To view the next page of the listing, press **PUSH JOG**  $\Delta \nabla \triangleleft \triangleright$ . The blueback

PR	CH	ID	PR	CH	ID
01	25	ARD	08	C26	E-SP
02	C08	SKY	09	55	WEST
03	10	ZDF	10	C24	SAT1
04	C65	RAI1	11	C23	OSF
05	C31	BBC1	12	C25	ESPN
06	C32	BBC2	13	C37	CNN
07	C33	3SAT	14	C35	

Navigation options at the bottom of the screen:  
 [Left Arrow] [Right Arrow]  
 → [OK] : EDIT  
 → [CANCEL] : DELETE  
 [MENU] : EXIT

screen and the program currently being broadcast by the blinking station appear alternately for 5 seconds each.

- The stations located in the selected country appear at the top of the list.
- The Guide Program numbers will also be set automatically during Auto Channel Set.

## RETURN TO NORMAL SCREEN

7

Press **MENU**.

- Depending on the reception conditions, the stations may not be stored in order, and the station names may not be stored correctly.
- Using the Confirmation screen, you can skip or add channel positions, enter station names and perform other operations. Refer to pages 46 – 47 for the procedures.
- For information on scrambled broadcasts, refer to page 46.

## NOTE:

*Fine tuning is performed automatically during Auto Channel Set. If you want to perform it manually, refer to page 47.*

## Storing Channels Manually

Store channels that were not stored during Auto Set Up (☞ pg. 44) or Auto Channel Set (☞ pg. 44).

\* In Australia and New Zealand, channels cannot be stored properly even though the following procedure is performed.

- 1** **ACCESS MAIN MENU**  
Press **MENU** twice.
- 2** **ACCESS CONFIRMATION SCREEN**  
Press **PUSH JOG**  $\Delta \nabla$  to move the highlight bar (pointer) to "MANUAL CH SET", then press **OK**. The Confirmation screen appears.
- 3** **SELECT POSITION**  
Press **PUSH JOG**  $\Delta \nabla$   $\triangleleft \triangleright$  until an open position in which you want to store a channel begins blinking, then press **OK**. The Manual Ch. Set screen appears.
- 4** **INPUT CHANNEL**  
The number "01" appears blinking beneath "CH". Press the **NUMBER** keys to input the channel number you want to store.
  - For fine tuning adjustment, press **PUSH JOG**  $\triangleright$  until the item beneath "CH" begins blinking, then press **PUSH JOG**  $\Delta \nabla$ . While tuning, "F+" or "F-" appears.
  - If necessary, to change the band between CH(regular) and CC(cable), press **PUSH JOG**  $\triangleleft \triangleright$  until CH or CC is blinking, then press **PUSH JOG**  $\Delta \nabla$  to select the band.
  - When storing a channel that sends scrambled broadcasts, press **PUSH JOG**  $\triangleright$  until "OFF" (Decoder setting) blinks, then press **PUSH JOG**  $\Delta \nabla$  to set "DECODER" to "ON" ("OFF" is the default setting).
- 5** **ENTER NEW CHANNEL INFORMATION**  
Press **OK** and the Confirmation screen appears.
  - Repeat steps **3** through **5** as necessary.
- 6** **CLOSE CONFIRMATION SCREEN**  
Press **MENU**.
  - To input the station name, see page 47.
  - To change positions, see "Change Station Channel Position" (at right).

### When Receiving A Scrambled Broadcast

Make sure that "AV2 SELECT" is set to "DECODER" (☞ pg. 34).

- 1- Perform steps **1** and **2** above.
- 2- Press **PUSH JOG**  $\Delta \nabla$   $\triangleleft \triangleright$  to select the position of the channel broadcasting the scrambled programmes, then press **OK** three times.
- 3- Press **PUSH JOG**  $\triangleright$  until "OFF (Decoder setting)" begins blinking, and set it to "ON" by pressing **PUSH JOG**  $\Delta \nabla$ .
- 4- Press **OK** to access the Confirmation screen.
  - Repeat steps **2** - **4** for each additional channel.
- 5- Press **MENU**.

Perform steps **1** and **2** of the previous procedure to access the Confirmation screen before continuing.

## Delete A Channel

- 1** **SELECT ITEM**  
Press **PUSH JOG**  $\Delta \nabla$   $\triangleleft \triangleright$  until the item you want to delete begins blinking.
- 2** **DELETE CHANNEL**  
Press **CANCEL**.
  - The item directly beneath the cancelled one moves up one line.
  - Repeat steps **1** and **2** as necessary.
- 3** **CLOSE CONFIRMATION SCREEN**  
Press **MENU**.

## Change Station Channel Position

- 1** **SELECT ITEM**  
Press **PUSH JOG**  $\Delta \nabla$   $\triangleleft \triangleright$  until the item you want to move begins blinking. Then press **OK** and the station name (ID) and its channel (CH) number begin blinking.
- 2** **SELECT NEW POSITION**  
Press **PUSH JOG**  $\Delta \nabla$   $\triangleleft \triangleright$  to move the station to the new channel position, then press **OK**.
 

**Example:** If you moved the station in position 3 to position 7, the stations originally in positions 4-7 each move up one space.

  - Repeat steps **1** and **2** as necessary.
- 3** **CLOSE CONFIRMATION SCREEN**  
Press **MENU**.

Perform steps 1 and 2 of "Storing Channels Manually" on page 46 to access the Confirmation screen before continuing.

## Set Stations (A)

**1** **SELECT ITEM**  
Press **PUSH JOG**  $\Delta \nabla \triangleleft \triangleright$  until the item you want begins blinking. Then press **OK** twice and the station's name (ID) begins blinking.

**2** **SELECT NEW STATION**  
Press **PUSH JOG**  $\Delta \nabla$  until the new station's name (ID) you want to store begins blinking. Registered station names (see pg. 48) appear as you press **PUSH JOG**  $\Delta \nabla$ .

**3** **SWITCH STATIONS**  
Press **OK**.

- Repeat steps 1 through 3 as necessary.

**4** **CLOSE CONFIRMATION SCREEN**  
Press **MENU**.

## Fine-Tuning Channels Already Stored

**1** **SELECT CHANNEL TO FINE-TUNE**  
Press **PUSH JOG**  $\Delta \nabla \triangleleft \triangleright$  until the channel you want to tune begins blinking.

**2** **ACCESS MANUAL CH. SET SCREEN**  
Press **OK** three times. The Manual Ch. Set screen appears.

**3** **PERFORM TUNING**  
Press **PUSH JOG**  $\Delta \nabla$  until the picture is its clearest. Then press **OK**.

- The Confirmation screen appears.
- Repeat steps 1 through 3 as necessary.

**4** **CLOSE CONFIRMATION SCREEN**  
Press **MENU**.

## Set Stations (B)

### NOTE:

First perform step 1 of the above procedure.

**2** **SELECT STATION NAME CHARACTER**  
Press **PUSH JOG**  $\triangleright$  and the first letter of the station name begins blinking.

**3** **ENTER NEW CHARACTER**  
Press **PUSH JOG**  $\Delta \nabla$  to cycle through the characters (A-Z, 0-9, -, \*, +, — (space)) and stop when the desired one is indicated, then press **PUSH JOG**  $\triangleright$  to enter. Enter the remaining characters the same way (maximum of 4). After entering all characters, press **OK**.

- Repeat steps 1 through 3 as necessary.
- If you make a mistake, press **PUSH JOG**  $\triangleleft$  until the incorrect character begins blinking. Then enter the correct character by pressing **PUSH JOG**  $\Delta \nabla$ .

**4** **CLOSE CONFIRMATION SCREEN**  
Press **MENU**.

## TV Station And ID List

ID*	STATION NAME
1000	TV1000
3SAT	3SAT
ADLT	ADULT
ANT3	ANTENA3
ARD	ARD
ARTE	ARTE
BBC	BBC GROUP
BBC1	BBC1
BBC2	BBC2
BR3	BAYERN3
C+	CANAL PLUS
C1	PORTUGUSES
CAN5	CANALE5
CH4	CHANNEL4
CH5	CHANNEL5
CHLD	CHILD
CINE	CINEMA
CLUB	TELECLUB
CMT	CMT
CNN	CNN
CSUR	ANDALUCIA
DISC	DISCOVERY
DR	DR TV
DRS	DRS
DSF	DSF
ETB1	ETB1
ETB2	ETB2
EURO	EURONEWS
EUSP	EUROSPORTS
FEMM	FEMMAN
FILM	FILM
FNET	FILMNET
FR2	France2
FR3	France3
GALA	GALAVISION
HR3	HESSEN3
INFO	INFO-KANAL
ITA1	ITALIA1
ITA7	ITALIA7
ITV	ITV
JSTV	JSTV
KA2	KA2
KAB1	KABEL1
KAN2	KANAL2
LOCA	LOCAL
M6	M6
MBC	MBR
MCM	MCM
MDR	MDR
MOVE	MOVIE
MTV	MTV
MTV3	MTV3
N3	NORD3
N-TV	N-TV
NBC	NBC SUPER
NDR3	NDR3
NED1	NED1
NED2	NED2
NED3	NED3
NEWS	
NICK	NICKELODEON
NRK	NRK
NRK2	NRK2
ODE	ODEON
ORF1	ORF1

ID*	STATION NAME
ORF2	ORF2
ORF3	ORF3
OWL3	OWL3
PREM	PREMIERE
PRO7	PRO7
RAI1	RAI1
RAI2	RAI2
RAI3	RAI3
RET4	RETE4
21	TELE21
RTBF	RTBF1 or 2
RTL	RTL
RTL2	RTL2
RTL4	RTL4
RTL5	RTL5
RTP	RTP
S4	SCHWEIZ4
SAT1	SAT1
SBS	SBS
SHOW	SHOW
SIC	SOCIEDADE
SKY	SKY CHANNEL
SKYN	SKY NEWS
SPRT	SPORT
SRTL	SUPER RTL
STAR	STAR-TV
SVT1	SVT1
SVT2	SVT2
SW3	SUEDWEST3
TCC	TCC
TELE	TELE
TEL5	TELE5
TF1	TF1
TM3	TM3
TMC	TELEMONTECARLO
TNT	TNT INT
TRT	TRT INT
TSI	TSI
TSR	TSR
TV1	BRTN TV1
TV2	BRTN TV2
TV3	TV3
TV4	TV4
TV5	TV5
TV6	TV6
TVE1	TVE1
TVE2	TVE2
TVG	TV GALICIA
TVI	TV INDEPENDENT
TVN	TV NORGE
VCR	VIDEO
VERO	VERONICA
VH-1	VH-1
VIVA	VIVA
VIV2	VIVA2
VMTV	VIDEO MUSIC
VOX	VOX
VT4	VT4
VTM	VTM
WDR1	West1
WDR3	West3
YLE1	YLE1
YLE2	YLE2
ZDF	ZDF
ZTV	ZTV

\* The "ID" abbreviation is what is shown on-screen in lieu of the station name. The "ID" abbreviation is listed in the Confirmation screen and is displayed on the TV screen when the recorder is tuned to a different station.



Turn on the TV and select the VIDEO channel (or AV mode).

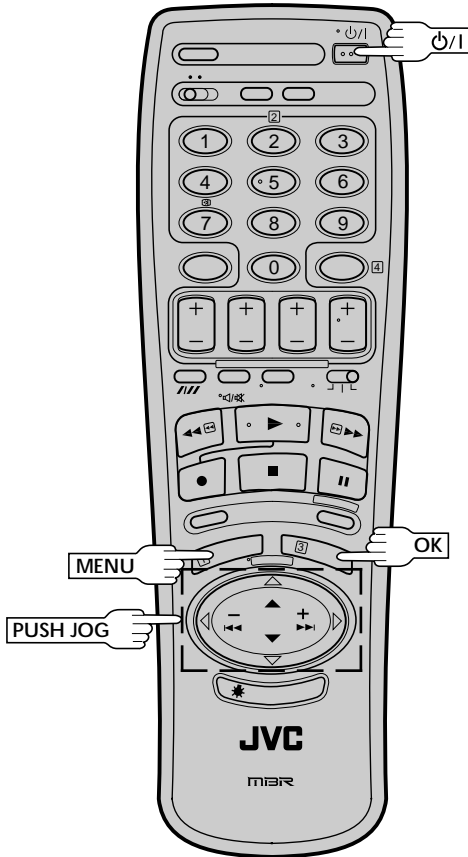

## IMPORTANT

Perform the following steps only if auto clock set has not been set correctly by Auto Set Up function (pg. 4) or Auto Channel Set (pg. 44) or if the recorder's memory backup has expired.

If you performed Auto Set Up or Auto Channel Set without ever having set the clock previously, the recorder's built-in clock is also set automatically. The Auto and Manual clock setting procedures are necessary when . . .

- a power outage of more than 60 minutes occurs.
- the tuner has been set manually.
- the user desires to set the clock slightly ahead of the actual time.
- the clock was not set even after Auto Set Up or Auto Channel Set was performed.

Whether you perform Auto or Manual clock setting, you can use the convenient Just Clock function.

## Just Clock

The Just Clock function provides accurate time keeping through automatic adjustments at regular intervals, by reading data from a PDC signal.

The Just Clock option appears in the Clock Set and Auto Clock screens, and can be set "ON" or "OFF" (the default setting is "OFF"). Press **OK** until the Just Clock setting begins blinking, then press **PUSH JOG**  $\Delta \nabla$  to change the setting.

**IMPORTANT:** If you turn off Just Clock, the accuracy of your recorder's built-in clock may be reduced, which could adversely effect timer recording. We recommend you to keep Just Clock on. In cases where the clock setting data from a PDC signal is incorrect, however, you are advised to keep Just Clock set to "OFF".

\* Just Clock does not work in areas where no TV station transmits PDC signals.

Both Auto and Manual clock setting procedures begin from step 4.

## Preparation

### 1 TURN THE RECORDER ON

Press  $\text{PWR}$ .

### 2 ACCESS MAIN MENU SCREEN

Press **MENU** twice.

### 3 ACCESS CLOCK SET SCREEN

Move the highlight bar (pointer) to "CLOCK SET" by pressing **PUSH JOG**  $\Delta \nabla$ , then press **OK**. The Clock Set screen appears.

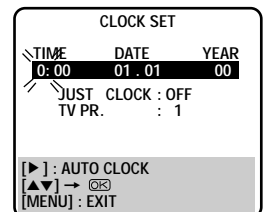
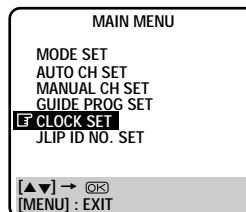

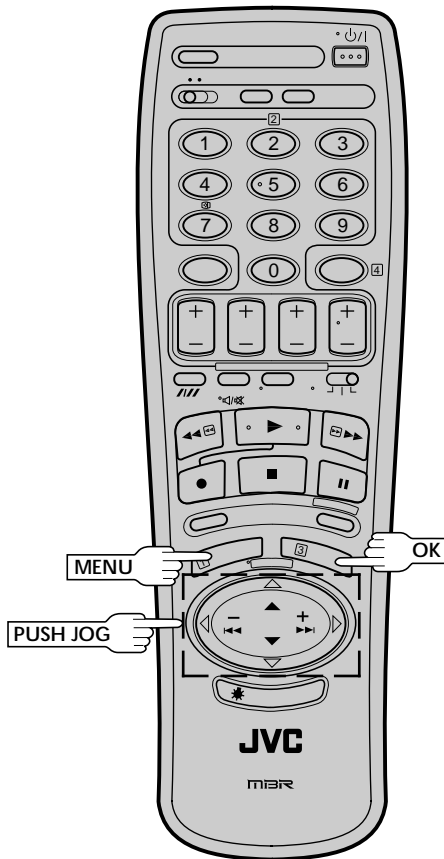

## NOTES:

- Auto Clock and Just Clock require a PDC signal, and will not operate with a VPS signal.
- Just Clock (when set to "ON") enables adjustment of the recorder's built-in clock every hour on the hour, except for 23:00, 0:00, 1:00 and 2:00.
- Just Clock is not effective when . . .
  - the recorder's power is on (unless the recorder is tuned to the same channel position selected in the Clock Set screen).
  - the recorder is in the Timer mode.
  - a difference of more than 3 minutes exists between the built-in clock's time and the actual time.
- If Just Clock is set to "ON", the recorder's clock is automatically adjusted at the start/end of Summer Time.
- Auto clock setting and Just Clock may not function properly depending on the reception condition.
- During Manual clock setting, if the day and month data are invalid (such as 31st April), the month digits are cleared automatically and the day digits begin blinking. Input the correct data.
- If, in step 4 of the Manual clock setting procedure, the year digits are automatically cleared and the day digits begin blinking, it is possible that you have input 29th February for a non-leap year. Input the correct data.

## Auto Clock Set

### 4 SET CLOCK AUTOMATICALLY

At the Clock Set screen, press **PUSH JOG**▷. The Auto Clock screen appears and clock setting begins.

```

  AUTO CLOCK
  PLEASE WAIT
  JUST CLOCK : OFF
  TV. PR      : 1
  
```

- If "TV PR." isn't set to the channel position on which Auto Clock data is received, "ERROR" appears, and then the screen from step 3 reappears. To set "TV PR.", press **OK** to place the pointer next to it, then cycle through the numbers by pressing **PUSH JOG**△▽ until the number representing the channel position in which the station transmitting clock setting data is stored appears.

### 5 RETURN TO NORMAL SCREEN

Once clock setting is completed, press **MENU** to return to the normal screen.

## Manual Clock Set

### 4 SET DATE AND TIME

Press **PUSH JOG**△▽ to set the hour, then press **OK**. The "minutes" display begins blinking. Repeat the procedure to set the minutes, day, month and year.

### 5 SET JUST CLOCK

The default setting is "OFF". Set as desired by pressing **PUSH JOG**△▽, then press **OK**.

- If you set to "OFF", you can disregard the next step as you won't be able to receive regular clock adjustments.

### 6 SET CLOCK DATA SOURCE CHANNEL POSITION

The recorder is preset to receive clock setting and adjustment data from channel position 1. Press **PUSH JOG**△▽ to set the channel position to the number representing the station transmitting clock setting data, then press **OK**.

### 7 START CLOCK OPERATION

Press **MENU**.

Before requesting service for a problem, use this chart and see if you can repair the trouble yourself. Small problems are often easily corrected, and this can save you the trouble of sending your video recorder off for repair.

## POWER

SYMPTOM	POSSIBLE CAUSE	CORRECTIVE ACTION
1. No power is applied to the recorder.	<ul style="list-style-type: none"> <li>The mains power cord is disconnected.</li> </ul>	Connect the mains power cord.
2. The clock is functioning properly, but the recorder cannot be powered.	<ul style="list-style-type: none"> <li>"⊖" is displayed on the display panel with Auto Timer set to "OFF".</li> </ul>	Press the <b>TIMER</b> button to turn the "⊖" indicator off.

## TAPE TRANSPORT

SYMPTOM	POSSIBLE CAUSE	CORRECTIVE ACTION
1. The tape does not run during recording.	<ul style="list-style-type: none"> <li>"□□" is displayed on the display panel.</li> </ul>	Press <b>PLAY</b> to turn the "□□" indicator off.
2. The tape stops during rewind or fast-forward.	<ul style="list-style-type: none"> <li>"M" is displayed on the display panel.</li> </ul>	Press <b>C.MEMORY</b> to deactivate the Counter Memory function and turn the "M" indicator off.
3. The tape will not rewind or fast-forward.	<ul style="list-style-type: none"> <li>The tape is already fully rewound or fast-forwarded.</li> </ul>	Check the cassette.

## PLAYBACK

SYMPTOM	POSSIBLE CAUSE	CORRECTIVE ACTION
1. The playback picture does not appear while the tape is running.	<ul style="list-style-type: none"> <li>If you're using the RF OUT connection . . . . . the TV receiver's channel selector is not set to the VIDEO channel. . . . . the recorder's VIDEO channel has not been correctly set.</li> <li>If you're using the AV connection, the TV receiver is not set to the AV mode.</li> </ul>	<p>If you are using the RF OUT connection . . . . . set the TV receiver to the VIDEO channel. (☞ pg. 8)</p> <p>. . . Perform "Video Channel Set" (☞ pg. 8)</p> <p>If you are using the AV connection, set the TV to its AV mode.</p>
2. Noise appears during normal playback.	<ul style="list-style-type: none"> <li>The automatic tracking mode is engaged.</li> </ul>	Try manual tracking. (☞ pg. 14)
3. Noise appears during slow-motion playback.	<ul style="list-style-type: none"> <li>The automatic tracking mode is engaged.</li> </ul>	Try manual tracking. (☞ pg. 14)
4. Noise appears during still playback.		Press <b>TV PROG.+</b> or <b>-</b> a few times to remove the noise bars from the screen.
5. Breaks are noticeable in Hi-Fi soundtrack	<ul style="list-style-type: none"> <li>Automatic tracking is engaged.</li> </ul>	Engage and adjust tracking manually. (☞ pg. 14)
6. The playback picture is blurred or interrupted while TV broadcasts are clear.	<ul style="list-style-type: none"> <li>The video heads may be dirty.</li> </ul>	Consult your JVC dealer.

## RECORDING

SYMPTOM	POSSIBLE CAUSE	CORRECTIVE ACTION
1. Recording cannot be started.	<ul style="list-style-type: none"> <li>There is no cassette loaded, or the cassette loaded has had its Record Safety tab removed.</li> </ul>	Insert a cassette, or using adhesive tape, reseal the slot where the tab was removed.
2. TV broadcasts cannot be recorded.	<ul style="list-style-type: none"> <li>"AU" has been selected as the input mode.</li> </ul>	Set to the desired channel.
3. Tape-to-tape editing is not possible.	<ul style="list-style-type: none"> <li>The source (another video recorder, camcorder) has not been properly connected.</li> <li>All necessary power switches have not been turned on.</li> <li>The input mode is not correct.</li> </ul>	<p>Confirm that the source is properly connected.</p> <p>Confirm that all units' power switches are turned on.</p> <p>Set the input mode to "AU".</p>

4. Camcorder recording is not possible.

- The camcorder has not been properly connected.
- The input mode is not correct.

Confirm that the camcorder is properly connected.  
Set the input mode to "AU".

## TIMER RECORDING

SYMPTOM	POSSIBLE CAUSE	CORRECTIVE ACTION
1. Timer recording won't work.	<ul style="list-style-type: none"> <li>● The clock and/or the timer have been set incorrectly.</li> <li>● The timer is not engaged.</li> </ul>	Re-perform the clock and/or timer settings. Press <b>TIMER</b> and confirm that "⊖" is displayed on the display panel.
2. On-screen timer programming is not possible.	<ul style="list-style-type: none"> <li>● Timer recording is in progress.</li> </ul>	Timer programming can't be performed while a timer recording is in progress. Wait until it finishes.
3. "⊖" and "⊖" on the display panel won't stop blinking.	<ul style="list-style-type: none"> <li>● The timer is engaged but there's no cassette loaded.</li> </ul>	Load a cassette with the Record Safety tab intact, or cover the hole using adhesive tape.
4. The cassette is automatically ejected, and "⊖" and "⊖" on the display panel won't stop blinking.	<ul style="list-style-type: none"> <li>● The loaded cassette has had its Record Safety tab removed.</li> </ul>	Remove the cassette and cover the hole with adhesive tape, or insert a cassette with the Record Safety tab intact.
5. "⊖" blinks for 10 seconds and the Timer mode is disengaged.	<ul style="list-style-type: none"> <li>● <b>TIMER</b> has been pressed when there are no programs in memory, or the timer record information has been programmed incorrectly.</li> </ul>	Check the programmed data and re-program as necessary, then press <b>TIMER</b> again.
6. The cassette is automatically ejected, the power shuts off and "⊖" and "⊖" won't stop blinking.	<ul style="list-style-type: none"> <li>● The end of the tape was reached during timer recording.</li> </ul>	The programme may not have been recorded in its entirety. Next time make sure you have enough time on the tape to record the entire programme.
7. SHOWVIEW does not timer-record properly.	<ul style="list-style-type: none"> <li>● The recorder's channel positions have been set incorrectly.</li> </ul>	Refer to "Guide Program Number Set" and re-perform the procedure (☞ pg. 10).

## OTHER PROBLEMS

SYMPTOM	POSSIBLE CAUSE	CORRECTIVE ACTION
1. Whistling or howling is heard from the TV during camcorder recording.	<ul style="list-style-type: none"> <li>● The camcorder's microphone is too close to the TV.</li> <li>● The TV's volume is too high.</li> </ul>	Position the camcorder so its microphone is away from the TV. Turn the TV's volume down.
2. When scanning channels, some of them are skipped over.	<ul style="list-style-type: none"> <li>● Those channels have been designated to be skipped.</li> </ul>	If you need the skipped channels, restore them (☞ pg. 46).
3. The channel cannot be changed.	<ul style="list-style-type: none"> <li>● Recording is in progress.</li> </ul>	Press <b>PAUSE</b> to pause the recording, change channels, then press <b>PLAY</b> to resume recording.
4. The remote control won't operate the TV or satellite tuner.	<ul style="list-style-type: none"> <li>● The <b>TV/SAT./VCR</b> switch is in the wrong position.</li> </ul>	Set the switch to the correct position.
5. Channel settings that were made manually seem to have changed or disappeared.	<ul style="list-style-type: none"> <li>● After the manual settings were made, Auto Channel Set was performed.</li> </ul>	Perform manual setting again.
6. No channels are stored in the recorder's memory.	<ul style="list-style-type: none"> <li>● The TV aerial cable was not connected to the recorder when Auto Set Up was performed.</li> </ul>	Connect the TV aerial cable to the recorder properly and turn off the recorder power once, then turn the recorder power back on again. The recorder will try Auto Set Up again (☞ pg. 4).

**PLAYBACK**

- Q. What happens if the end of the tape is reached during playback or search?**  
**A.** The tape is automatically rewound to the beginning.  
 .....
- Q. Can the video recorder indefinitely remain in the still mode?**  
**A.** No. It stops automatically after 5 minutes to protect the heads.  
 .....
- Q. When returning from multi-speed search to normal playback, the picture is disturbed. Should I be concerned about this?**  
**A.** No, it is normal.  
 .....
- Q. Other than preventing further recording, what effect does removing the Record Safety tab have?**  
**A.** It disables marking of index codes.  
 .....
- Q. Sometimes, during Index Search, the video recorder can't find the programme I want to see. Why not?**  
**A.** There may be index codes too close together.  
 .....

**RECORDING**

- Q. When I pause and then resume a recording, the end of the recording before the pause is overlapped by the beginning of the continuation of recording. Why does this happen?**  
**A.** This is normal. It reduces distortion at the pause and resume points.  
 .....
- Q. Can the video recorder indefinitely remain in the Record-Pause mode?**  
**A.** No. The video recorder goes to its Stop mode automatically after 5 minutes to protect the heads.  
 .....
- Q. What happens if the tape runs out during recording?**  
**A.** The video recorder automatically rewinds it to the beginning.  
 .....

**TIMER RECORDING**

- Q. "O" and "⊖" remain lit on the display panel. Is there a problem?**  
**A.** No. This is a normal condition for a timer recording in progress.  
 .....
- Q. Can I program the timer while I'm watching a tape or a TV broadcast?**  
**A.** You won't see the picture as it is replaced by the on-screen menu, but the audio from the program or tape you're viewing can be heard.  
 .....

**ATTENTION:**

This recorder contains microcomputers. External electronic noise or interference could cause malfunctioning. In such cases, switch the recorder off and unplug the mains power cord. Then plug it in again and turn the recorder on. Take out the cassette. After checking the cassette, operate the unit as usual.

## FRONT VIEW

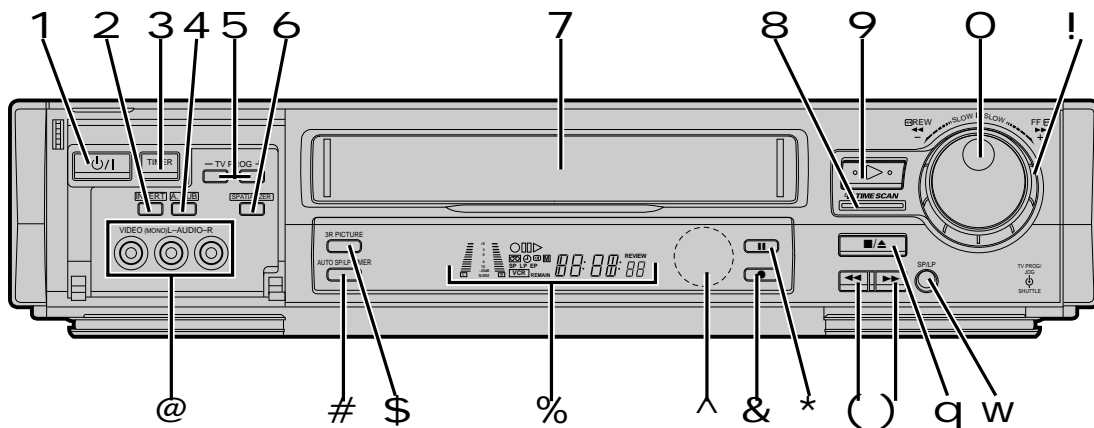

Open the lid to access covered connectors and buttons.

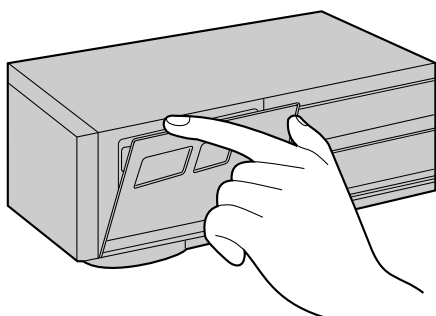

1 STANDBY/ON  $\psi$ /I Button  $\text{☞}$  pg. 4

2 INSERT Button  $\text{☞}$  pg. 39

3 TIMER Button  $\text{☞}$  pg. 29, 31

4 A. DUB [Audio Dubbing] Button  $\text{☞}$  pg. 37

5 TV PROG. +/- Buttons  $\text{☞}$  pg. 21

6 SPATIALIZER Button  $\text{☞}$  pg. 16

7 Cassette Loading Slot

8 TIME SCAN Indicator  $\text{☞}$  pg. 18

9 PLAY Button  $\text{☞}$  pg. 12

0 TV PROG. Dial  $\text{☞}$  pg. 21

JOG Dial  $\text{☞}$  pg. 13

! TIME SCAN SHUTTLE Ring  $\text{☞}$  pg. 18

@ VIDEO/AUDIO Input Connectors  $\text{☞}$  pg. 36

# AUTO SP/LP TIMER Button  $\text{☞}$  pg. 33

\$ 3R PICTURE Button  $\text{☞}$  pg. 14

% Display Panel  $\text{☞}$  pg. 55

^ Infrared Beam Receiving Window

& RECORD Button  $\text{☞}$  pg. 21

\* PAUSE Button  $\text{☞}$  pg. 13

( Rewind [REW] Button  $\text{☞}$  pg. 12

) Fast Forward [FF] Button  $\text{☞}$  pg. 12

q STOP/EJECT Button  $\text{☞}$  pg. 12

w SP/LP Button  $\text{☞}$  pg. 21

## REAR VIEW

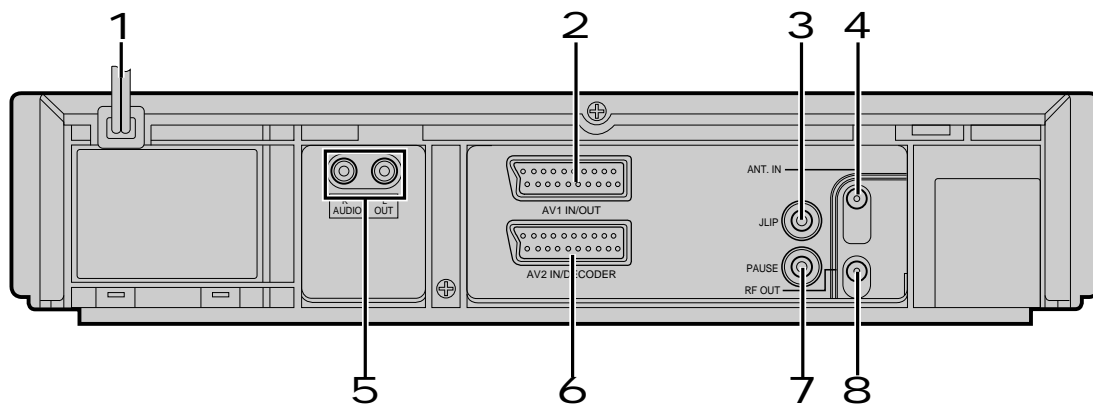

- 1 Mains Power Cord ☞ pg. 3
- 2 AV1 IN/OUT Connector ☞ pg. 3, 34
- 3 J Terminal [JLIP (Joint Level Interface Protocol) Connector] ☞ pg. 40
- 4 ANT. IN Connector ☞ pg. 3
- 5 AUDIO OUT (L/R) Connectors ☞ pg. 3
- 6 AV2 IN/DECODER Connector ☞ pg. 34, 41
- 7 Remote PAUSE Connector ☞ pg. 36
- 8 RF OUT Connector ☞ pg. 3

## DISPLAY PANEL

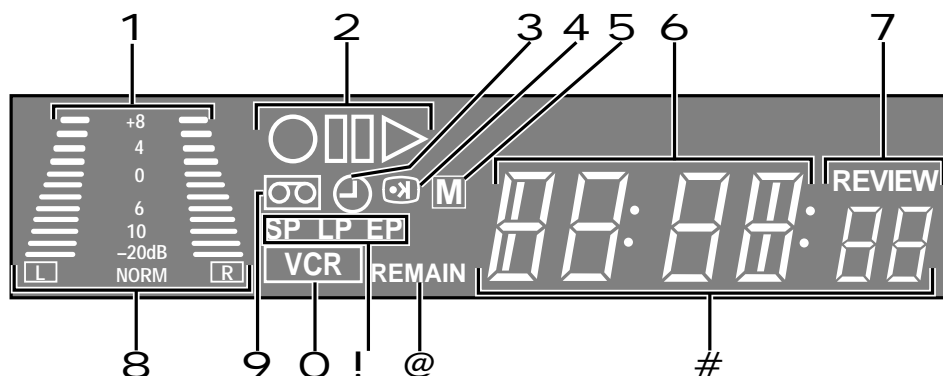

- 1 B.E.S.T. Picture System Display ☞ pg. 22
- Audio Level Indicator
- 2 Symbolic Mode Indicators
- 3 "Timer" Indicator ☞ pg. 29, 31
- 4 PDC/VPS Indicator ☞ pg. 33
- 5 Counter Memory Indicator ☞ pg. 17
- 6 Channel\*/Mode Display ☞ pg. 21
- \* Channel position 1 will be displayed as "CH 1".
- Clock Display ☞ pg. 5, 49
- 7 Instant REVIEW Indicator ☞ pg. 15
- 8 Audio Mode Indicator ☞ pg. 16
- 9 "Cassette Loaded" Mark
- VCR Indicator ☞ pg. 25
- ! Tape Speed Indicators ☞ pg. 21
- @ Tape Remaining Time Indicator ☞ pg. 25
- # Counter/Remain Display ☞ pg. 25

PLAY: FF/REW VARIABLE SHUTTLE SEARCH:	▶	STILL:	▢▶
		SLOW:	▢▶
		RECORD:	○
RECORD PAUSE:		○▢▶	
AUDIO DUBBING:		⊙▶	
AUDIO DUBBING PAUSE:		⊙▢▶	
INSERT:		○▶	
INSERT PAUSE:		○▢▶	
AUDIO DUBBING INSERT:		⊙▶	
AUDIO DUBBING INSERT PAUSE:		⊙▢▶	

## REMOTE CONTROL

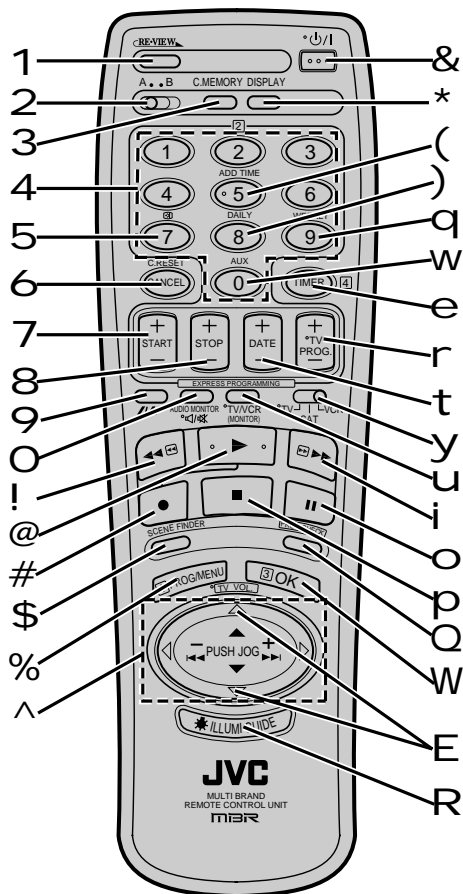

Buttons with a small dot on the left side of the name can also be used to operate your TV with the TV/SAT./VCR switch set to "TV". pg. 42

- 1 REVIEW Button pg. 15
- 2 A/B Code Switch pg. 17
- 3 C. MEMORY Button pg. 17
- 4 NUMBER Keys pg. 21, 28
- 5 (PDC/VPS) Button pg. 29, 31
- 6 CANCEL Button pg. 11
  - C. RESET Button pg. 25
- 7 START +/- Button pg. 30
- 8 STOP +/- Button pg. 30
- 9 SP/LP Button pg. 21
  - Auto Tracking Button pg. 14
  - Digit Entry Button pg. 42
- o AUDIO MONITOR Button pg. 16
  - TV Mute Button pg. 42
- ! Rewind [REW] Button pg. 12
- @ Play Button pg. 12
- # Record Button pg. 21
- \$ SCENE FINDER Button pg. 17
- % PROG./MENU Button pg. 7, 28
- ^ PUSH JOG pg. 7
  - PUSH JOG pg. 13, 15, 42
- & STANDBY/ON pg. 4
- \* DISPLAY Button pg. 25
- ( ADD TIME Button pg. 29
- ) DAILY Button pg. 29, 31
- q WEEKLY Button pg. 29, 31
- w AUX Button pg. 34
- e TIMER Button pg. 29, 31
- r TV PROG. +/- Button pg. 21
- t DATE +/- Button pg. 31
- y TV/SAT./VCR Switch pg. 42, 43
- u TV/VCR Button pg. 25, 42
- i Fast Forward [FF] Button pg. 12
- o Pause Button pg. 13
- p Stop Button pg. 12
- Q PROG. CHECK Button pg. 32
- W OK Button pg. 7
- E TV VOL pg. 42
- R ILLUMI GUIDE Button pg. 28

**Installing Batteries**

- 1 Open the battery compartment cover.
- 2 Insert 2 "R6"-size batteries (provided) in the correct directions.
- 3 Replace the cover.

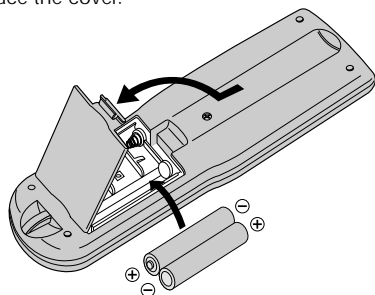
**How To Use**

The remote control can operate most of your video recorder's functions, as well as basic functions of TV sets and satellite tuners of JVC and other brands. pg. 42, 43.

- Point the remote control toward the sensor window.
- The maximum operating distance of the remote control is about 8 m.

**NOTE:**

*If the remote control doesn't work properly, remove its batteries, wait a short time and then try again.*



## GENERAL

Power requirement	: AC 220 – 240 V~, 50/60 Hz
Power consumption	: 24 W
Temperature	
Operating	: 5°C to 40°C
Storage	: -20°C to 60°C
Operating position	: Horizontal only
Dimensions (WxHxD)	: 430 x 94 x 348 mm
Weight	: 4.5 kg
Format	: VHS PAL standard
Maximum recording time	
(SP)	: 240 min. with E-240 video cassette
(LP)	: 480 min. with E-240 video cassette

## VIDEO/AUDIO

Signal system	: PAL-type colour signal and CCIR monochrome signal, 625 lines 50 fields
Recording system	: DA4 (Double Azimuth) head helical scan system
Signal-to-noise ratio	: 45 dB
Horizontal resolution	: 250 lines
Frequency range	: 70 Hz to 10,000 Hz (Normal audio) 20 Hz to 20,000 Hz (Hi-Fi audio)
Input/Output	: 21-pin scart connectors : IN/OUT x 1, IN/DECODER x 1 RCA connectors: VIDEO IN x 1, AUDIO IN x 1, AUDIO OUT x 1

## TUNER/TIMER

TV channel storage capacity	: 99 positions (+AUX position "AU")
Tuning system	: Frequency synthesized tuner
Channel coverage	
(Europe)	: VHF 47 – 89/104 – 300/ 302 – 470MHz UHF 470 – 862MHz
(Australia)	: CH0 – 5, 5A, CATV CH6 – 12, CATV CH28 – 69
(New Zealand)	: CH1 – 3, CATV CH4 – 11, CATV CH21 – 69
Aerial output	: UHF channels 22 – 69 (Adjustable)
Memory backup time	: Approx. 60 min.

## ACCESSORIES

Provided accessories	: RF cable, Infrared remote control unit, "R6" battery x 2, Input cable adapter* Output cable adapter*
----------------------	--

\* Provided in Australia and New Zealand only.

*Specifications shown are for SP mode unless otherwise specified.  
E.& O.E. Design and specifications subject to change without notice.*





# Auto Set Up - referring to the display panel

The Auto Set Up function sets the tuner channels, clock and Guide Program numbers automatically.

## BEFORE YOU START PLEASE MAKE SURE THAT:

- The TV aerial cable is connected to the ANT.IN jack on the rear panel of the video recorder.
- The video recorder's mains power cord is connected to a mains outlet.
- The video recorder is turned off.
- Load batteries into the remote control.

1 Press  $\text{O/I}$  (recorder/remote).



2 Press **PUSH JOG**  $\Delta \nabla$  (remote) to select the international telephone country code.

(Ex.) DEUTSCHLAND is selected.



- If you have selected a country code other than 32 (BELGIUM) or 41 (SUISSE), go to step 3.

### International Telephone Country Code

SUOMI	: 358	SUISSE	: 41
PORTUGAL	: 351	ITALIA	: 39
DEUTSCHLAND	: 49	ESPAÑA	: 34
NORGE	: 47	BELGIUM	: 32
SVERIGE	: 46	NEDERLAND	: 31
DANMARK	: 45	GREECE	: 30
ÖSTERREICH	: 43	OTHERS	: - -

\* Depending on the model, the selectable codes may be limited.

- If you have selected 32 (BELGIUM) or 41 (SUISSE), press **OK** (remote) and select the language code by pressing **PUSH JOG**  $\Delta \nabla$  (remote), then go to step 3.

(Ex.) FRANCAIS is selected for BELGIUM



International Telephone  
Country Code

Language Code

### Language Code for the HR-DD949E

ENGLISH	: 01	ITALIANO	: 04
DEUTSCH	: 02	NEDERLANDS	: 05
FRANCAIS	: 03		

### Language Code for the HR-DD949EH

ENGLISH	: 01	CASTELLANO	: 04
DEUTSCH	: 02	NEDERLANDS	: 05
FRANCAIS	: 03		

3 Press **OK** (remote). Do NOT press any button on the video recorder or remote control until the current time appears.



During Auto Set Up



Auto Set Up completed

- If "CH1" or "- -: - -" appears on the display panel, see page 5 of the instructions.

\* Once you have performed Auto Set Up, even if the recorder's memory backup has expired, the recorder will not perform Auto Set Up again.

FOR MORE INFORMATION SEE INSTRUCTIONS/P4

# JVC

VICTOR COMPANY OF JAPAN, LIMITED